

# JVC

## SERVICE MANUAL

### AUDIO/VIDEO CONTROL RECEIVER

## RX-5THRBK

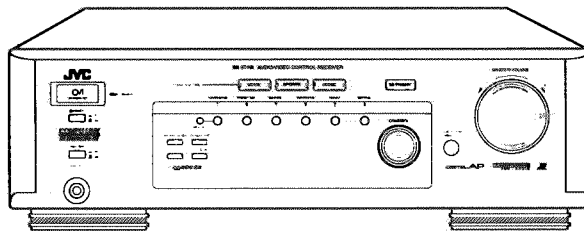

#### Area Suffix

BS	....	the U.K.
EF	....	Continental Europe Except Germany and Italy
EN	....	Nordic Countries
G	....	Germany

**COMPU LINK**  
/// Remote ///

**3D** 3D-PHONIC

### Contents

<i>Safety Precautions</i> .....	1-2	<i>Adjustment Procedures</i> .....	2-22
<i>Instruction Book</i> .....	1-3	<i>Block Diagrams</i> .....	2-25
<i>Description of Major ICs</i> .....	2-1	<i>Printed Circuit Boards</i> .....	2-26
<i>Internal Connection of Display</i> .....	2-19	<i>Schematic Diagrams</i> .....	2-31
<i>Disassembly Procedures</i> .....	2-20	<i>Parts List</i> .....	3-1

### **Safety Precautions**

1. The design of this product contains special hardware and many circuits and components specially for safety purposes. For continued protection, no changes should be made to the original design unless authorised in writing by the manufacturer. Replacement parts must be identical to those used in the original circuits.
2. Any unauthorised design alterations or additions will void the manufacturer's guarantee ; furthermore the manufacturer cannot accept responsibility for personal injury or property damage resulting therefrom.
3. Essential safety critical components are identified by ( $\triangle$ ) on the Parts List and by shading on the schematics ,and must never be replaced by parts other than those listed in the manual. Please note however that many electrical and mechanical parts in the product have special safety related characteristics . These characteristics are often not evident from visual inspection . Parts other than specified by the manufacturer may not have the same safety characteristics as the recommended replacement parts shown in the Parts List of the service manual and may create shock , fire , or other hazards .
4. The leads in the products are routed and dressed with ties, clamps, tubings, barriers and the like to be separated from live parts, high temperature parts, moving parts and/or sharp edges for the prevention of electric shock and fire hazard. When service is required, the original lead routing and dress should be observed, and it should be confirmed that they have been returned to normal, after re-assembling.

### **Warning**

1. Service should be performed by qualified personnel only.
2. This equipment has been designed and manufactured to meet international safety standards.
3. It is the legal responsibility of the repairer to ensure that these safety standards are maintained.
4. Repairs must be made in accordance with the relevant safety standards.
5. It is essential that safety critical components are replaced by approved parts.
6. If mains voltage selector is provided, check setting for local voltage .

- Parts Identification**..... 2
- Easy Set Up & Operations**..... 3
- Getting Started**..... 5
  - Before Installation..... 5
  - Checking the Supplied Accessories..... 5
  - Connecting the FM and AM (MW/LW) Antennas..... 6
  - Connecting the Speakers..... 7
  - Connecting Audio/Video Components..... 9
  - Connecting the Power Cord..... 11
  - Putting Batteries in the Remote Control..... 11
- Basic Operations**..... 12
  - Turning the Power On and Off (Standby)..... 12
  - Selecting the Source to Play..... 12
  - Adjusting the Volume..... 13
  - Outputting the Sound through the Front Speakers..... 13
  - Muting the Sound..... 13
  - Recording a Source..... 13
- Basic Settings**..... 14
  - Adjusting the Front Speaker Output Balance..... 14
  - Listening at Low Volume (Loudness)..... 14
  - Using the Sleep Timer..... 14
  - Selecting the Center Speaker Size..... 15
  - Using Visual Confirmation..... 16
- One Touch Operation**..... 17
  - About the One Touch Operation..... 17
  - Using the One Touch Operation..... 17
- Receiving Radio Broadcasts**..... 18
  - Tuning in Stations Manually..... 18
  - Using Preset Tuning..... 18
  - Selecting the FM Reception Mode..... 20
  - Using the RDS (Radio Data System) to Receive FM Stations..... 20
  - What Information Can RDS Signals Provide?..... 21
  - Searching for a Program by PTY Codes..... 22
  - Switching to a Broadcast Program of Your Choice Temporarily..... 24
- Using the Preset SEA Modes**..... 26
  - Selecting Your Favorite SEA Mode..... 26
- Using the Surround Processor**..... 28
  - Using JVC's 3D PHONIC Modes..... 29
  - Using the DAP Modes..... 31
  - Speaker Arrangement for Dolby Surround..... 33
  - Preparing for Dolby Surround..... 34
  - Using Dolby Surround..... 38
- Using the On-Screen Menus**..... 39
- COMPU LINK Remote Control System**..... 43
- Operating Other Components**..... 44
- Troubleshooting**..... 46
- Specifications**..... 47

## Parts Identification

Become familiar with the buttons and controls on the receiver before use.

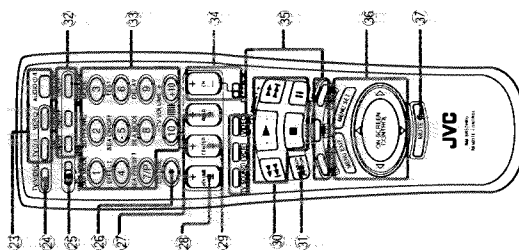
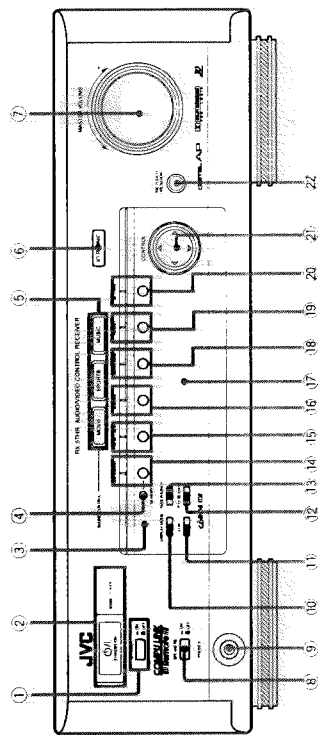

Refer to the pages in parentheses for details.

### Front Panel

- 1 POWER switch (11)
- 2 STANDBY/ON button and STANDBY lamp (11, 12)
- 3 Remote sensor (11)
- 4 MEMORY button (18)
- 5 SOUND CONTROL buttons and lamps (MOVIE, SPORTS, MUSIC) (26)
- 6 3D PHONIC button (29)
- 7 MASTER VOLUME control (13)
- 8 SPEAKERS button (13)
- 9 PHONES jack (13)
- 10 SURROUND button and lamp (31, 34)
- 11 EON button (24)
- 12 PTY SEARCH button (22)
- 13 TUNER/NEWS/INFO button (24)
- 14 TUNER/BAND button and lamp (18)
- 15 PRESET SEA button and lamp (26)
- 16 SOURCE button and lamp (12)
- 17 Display (12)
- 18 SURROUND button and lamp (31, 34)
- 19 ADJUST button and lamp (31, 34)
- 20 SETTING button and lamp (14)
- 21 CONTROL  $\Delta$  /  $\nabla$  /  $\leftarrow$  /  $\rightarrow$  button
- 22 ONE TOUCH OPERATION button and lamp (17)

### Remote Control

- 23 Power buttons (TV  $\odot$  /  $\square$ , VCR  $\odot$  /  $\square$ , AUDIO  $\odot$  /  $\square$ ) (12, 45)
- 24 TV/VIDEO button (45)
- 25 NUMERIC/AUDIO CONTROL selector (19, 32, 36)
- 26 CD-DISC button (44)
- 27 REAR buttons (+/-) (32, 37)
- 28 VOLUME buttons (+/-) (13)
- 29 CENTER buttons (+/-) (37)
- 30 Operating buttons for JVC audio/video components (44, 45)
- 31 RDS buttons (PTY SELECT (+/-), PTY SEARCH, DISPLAY MODE) (22, 23)
- 32 ONE TOUCH (OPERATION) button (17)
- 33 Sound effect ON/OFF buttons (DAP, 3D-PHONIC, SURROUND) (30, 32, 36)
- 34 10 keys/Audio control buttons/TV VOLUME buttons (+/-) (19, 27, 30, 44, 45)
- 35 CH (Channel) buttons (+/-) and TV/VCR selector (45)
- 36 Source buttons (TV SOUND, VCR1, VIDEO, TAPE/VCR, CD, FM/AM) (12, 44, 45)
- 37 Menu operating buttons (39)
- When using these buttons, make sure to show the menus on the TV.
- 38 MUTE button (13)

### IMPORTANT:

To use CONTROL  $\Delta$  /  $\nabla$  /  $\leftarrow$  /  $\rightarrow$  button (21) on the front panel: How this button works is mainly depending on which of the function selecting buttons (14, 15, 16, 18, 19, 20) for this button is pressed and the lamp is lit. Before using this button, make sure what lamp is lit. However if you press MENU SET (within 3s) on the remote control, this CONTROL  $\Delta$  /  $\nabla$  /  $\leftarrow$  /  $\rightarrow$  button will work as a menu operating button, though a lamp for the function selecting buttons is lit. If this happens, press the function selecting button you want to use again, then press CONTROL  $\Delta$  /  $\nabla$  /  $\leftarrow$  /  $\rightarrow$ .

# Easy Set Up & Operations

If you are already familiar with audio components, these two pages just you opened give you enough information to operate your RX-5THR BK for enjoyment of surround sound in your listening room.

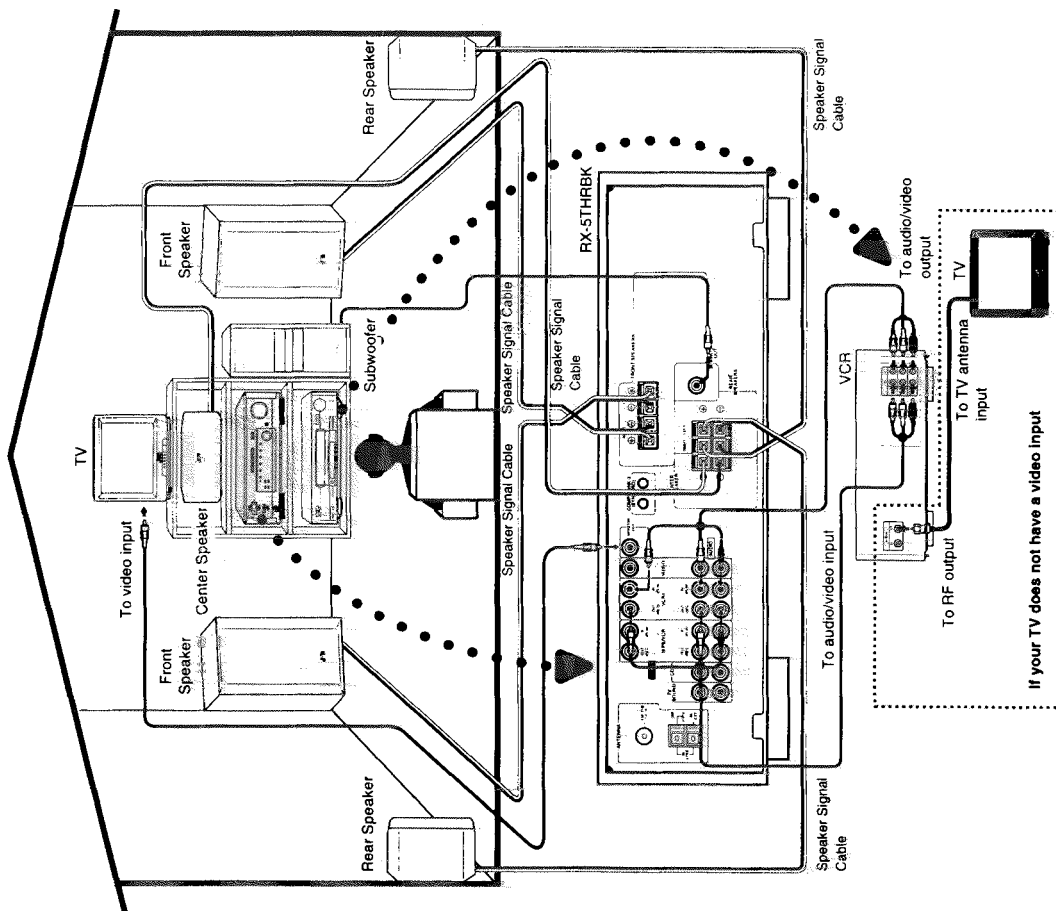

If your TV does not have a video input

1. Turn on the power.
2. Select the source.
3. Adjust the volume.
4. Turn on the surround mode.
5. Surround settings are preset at the factory. However, if you need to make further adjustments, see pages 28 to 38.

# Getting Started

This section explains how to connect stereo components and speakers to the receiver, and how to connect the power supply.

## Before Installation

### General

- Be sure your hands are dry.
- Turn the power off to all components.
- Read the manuals supplied with the components you are going to connect.

### Locations

- Install the receiver in a location that is level and protected from moisture.
- The temperature around the receiver must be between  $-5^{\circ}$  and  $35^{\circ}$  C ( $23^{\circ}$  and  $95^{\circ}$  F).
- Make sure there is good ventilation around the receiver. Poor ventilation could cause overheating and damage the receiver.

### Handling the receiver

- Do not insert any metal object into the receiver.
- Do not disassemble the receiver or remove screws, covers, or cabinet.
- Do not expose the receiver to rain or moisture.

## Checking the Supplied Accessories

Check to be sure you have all of the following items, which are supplied with the receiver.

The number in the parentheses indicates quantity of the pieces supplied.

- Remote Control (1)
- Batteries (2)
- AM (MW/LW) Loop Antenna (1)
- FM Antenna (1)

If anything is missing, contact your dealer immediately.

## Connecting the FM and AM (MW/LW) Antennas

### FM Antenna Connections

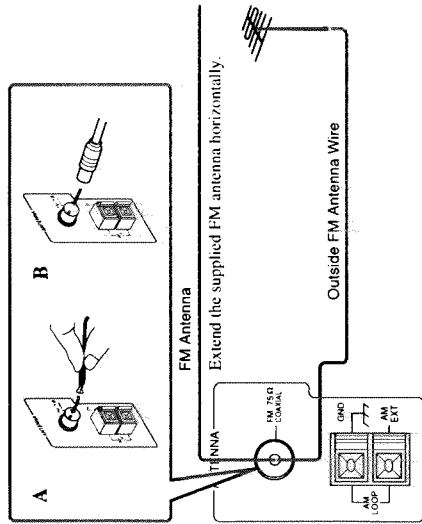

#### Note:

If reception is poor, connect the outside antenna. Before attaching a 75-ohm coaxial cable (the kind with a round wire going to an outside antenna), disconnect the supplied FM antenna.

### A. Using the Supplied FM Antenna

The FM antenna provided can be connected to the FM 75-ohm COAXIAL terminal as temporary measure.

### B. Using the Standard Type Connector (Not Supplied)

A standard type connector (IEC or DIN45325) should be connected to the FM 75-ohm COAXIAL terminal.

### AM (MW/LW) Antenna Connections

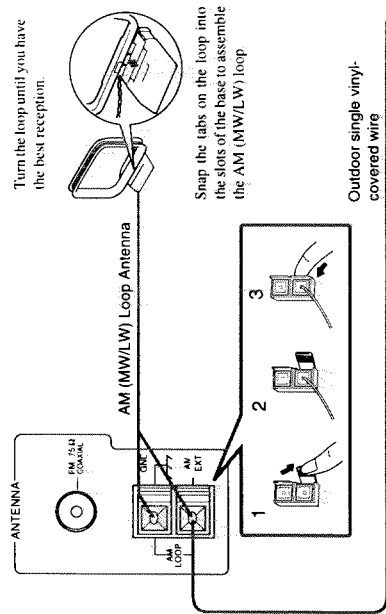

#### Notes:

- Make sure the antenna conductors do not touch any other terminals, connecting cords and power cord. This could cause poor reception.
- If reception is poor, connect an outdoor single vinyl-covered wire to the AM EXT terminal. (Keep the AM (MW/LW) loop antenna connected.)

# Getting Started

## Connecting the Speakers

You can connect the following speakers:

- One set of front speakers to produce normal stereo sound.
- One set of rear speakers to enjoy the surround effect.
- One center speaker to produce more effective surround effect (to make human voices outstanding).
- One subwoofer to enhance the bass.

For each speaker (except for subwoofer), connect one end of the speaker signal cable (not supplied) to the speaker terminal on the rear panel and the other end to the speaker.

1. Open each terminal.
2. Insert the end of the speaker signal cable as shown (be sure to remove the insulation at the end of each wire first).
3. Close the terminals to clamp the speaker signal cables firmly in place.
4. Connect the black (-) and red (+) terminals on the rear panel to the black (-) and red (+) terminals marked on the speakers.

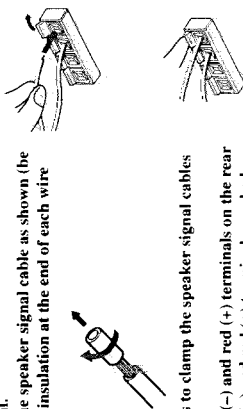

## Connecting the front speakers

Connect the front speakers to the FRONT SPEAKERS terminals.

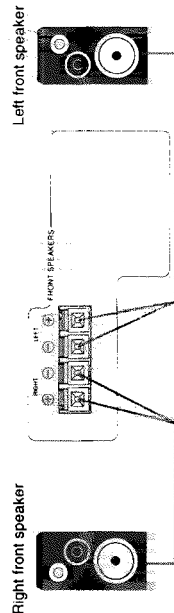

## Connecting the rear and center speakers

Connect the rear speakers to the REAR SPEAKERS terminals and the center speaker to the CENTER SPEAKER terminals.

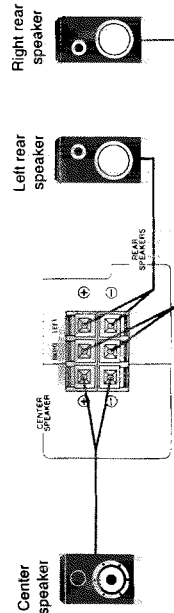

## About the speaker impedance of the speakers

The required speaker impedance of the front speakers differs depending on whether or not a center and/or rear speakers are connected at the same time. Since there are four possible speaker connections with the receiver, check which one fits your case and use the speaker with the impedance described below.

### CASE 1 When you connect only front speakers

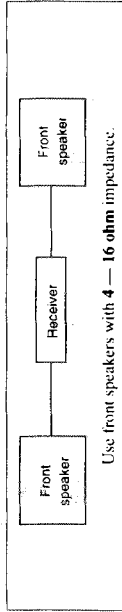

### CASE 2 When you connect front speakers and a center speaker

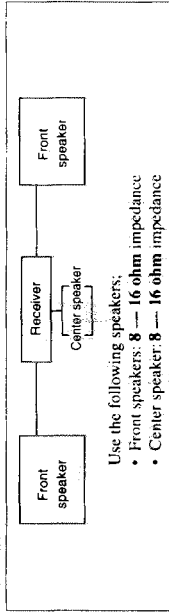

### CASE 3 When you connect front and rear speakers

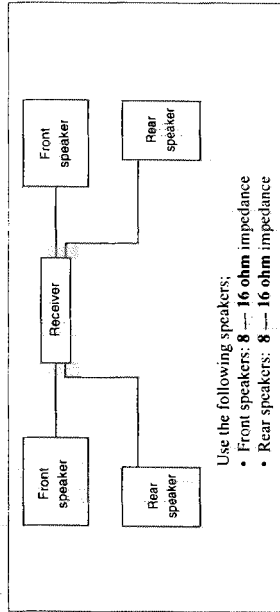

### CASE 4 When you connect a center speaker as well as front and rear speakers

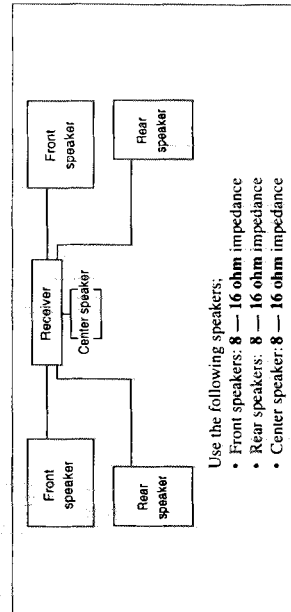

### CAUTION:

When connecting speakers, use speakers with the same SPEAKER IMPEDANCE indicated by the speaker terminals.

### CAUTION:

Use speakers with the same impedance as marked near the terminals on the rear panel.

### Notes:

- When you connect rear speakers, make sure that both left and right speakers are connected; otherwise, no sound will come out of the rear speakers.
- You can register the center speaker size after you finish its connection. If you register it, you do not have to set the center speaker mode while setting the surround mode. (If you do not use a center speaker, register that information.) See page 15.

# Getting Started

## Connecting the subwoofer speaker

Connect the input jack of a powered subwoofer to the SUBWOOFER OUT jack on the rear panel, using a cable with RCA pin plugs.

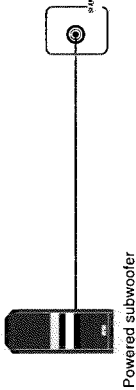

## Connecting Audio/Video Components

You can connect the following components to the receiver using cables with RCA pin plugs.

Audio Components	Video Components
<ul style="list-style-type: none"> <li>• CD player</li> <li>• Cassette deck</li> </ul>	<ul style="list-style-type: none"> <li>• VCR(s)</li> <li>• Video disc player</li> <li>• TV</li> </ul>

## Audio component connections

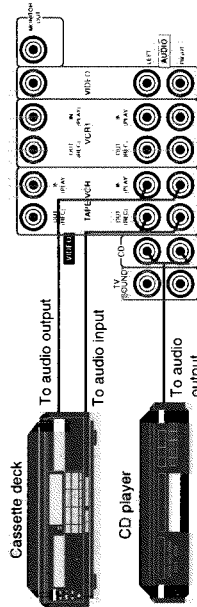

## If your audio components have a COMPU LINK-3 terminal

The COMPU LINK remote control system allows you to control other JVC audio components from the receiver or vice versa. Connect your audio components and the receiver with the cable (monaural mini-plug supplied with those components) as well as the connection above. For detailed information about the COMPU LINK-3 remote control system, see page 43.

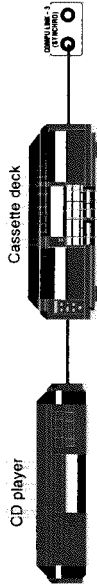

## Notes:

- The COMPU LINK-3 remote control system is the upgraded version of the COMPU LINK-1 and COMPU LINK-2. Even if your component has the COMPU LINK-1 or COMPU LINK-2 jacks, you can still connect it in the COMPU LINK-3 remote control system, but some functions may not work correctly.
- If your audio component has two COMPU LINK-3 (SYNCHRO) jacks, you can use either one.
- If it has only one COMPU LINK-3 (SYNCHRO) jack, connect it so that it is the last item in the series of components (for example, the CD player in the diagram).

## Note:

Use the video components of the PAL color system.

## Video component connections

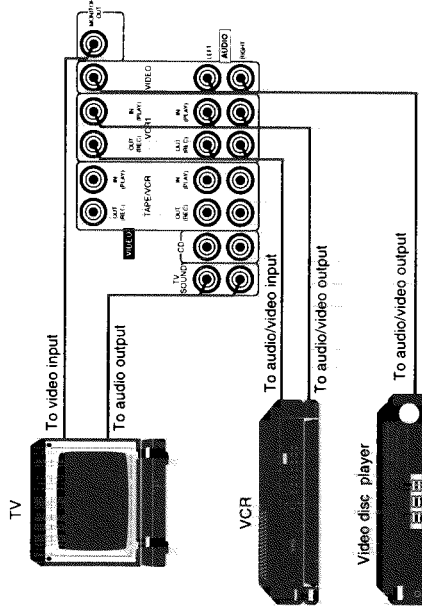

## Notes:

- You can connect either a cassette deck or a VCR to the TAPE/VCR jacks, whichever you want.
- If you want to operate the cassette deck using the COMPU LINK remote control system, connect the cassette deck to the TAPE/VCR jacks, not to the VCR1 jacks.

## CAUTION:

If you connect a sound-enhancing device such as a graphic equalizer between the source components and this receiver, the sound output through this receiver may be distorted.

## Getting Started

### Connecting the Power Cord

Before plugging the receiver into an AC outlet, make sure that all connections have been made.

Keep the power cord away from the connecting cables for the TV, VCR, and antenna. The power cord may cause noise or screen interference. We recommend that you use a coaxial cable to connect the antenna, since it is well-shielded against interference.

1. Plug the power cord into an AC outlet.
2. Press **POWER** to set it in the **ON** position. The STANDBY lamp lights up. A small amount of power is always consumed.



### To shut off the power completely:

Press **POWER** to set it in the **OFF** position.

### The difference between the **POWER** switch and the **STANDBY/ON** button

- The **POWER** switch is the mains supply switch, allowing the receiver to connect to the mains supply. To shut off the power completely, press the **POWER** switch to set it in the **OFF** position.
- The **STANDBY/ON** button is a functional on/off (standby) switch, and does not disconnect the receiver from the mains supply. A small amount of power is consumed even in standby mode for the receiver to accept signals from the remote control.

### Putting Batteries in the Remote Control

Before using the remote control, put the two supplied batteries in first. When using the remote control, aim the remote control directly at the remote sensor on the receiver.

1. On the back of the remote control, remove the battery cover as illustrated.
2. Insert batteries. Make sure to observe the proper polarity: (+) to (+) and (-) to (-).
3. Replace the cover.

R6P (SUM-3/AAA (15F))

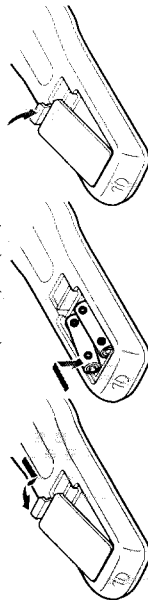

If the range or effectiveness of the remote control decreases, replace the batteries. Use two R6P (SUM-3/AAA (15F)) type dry-cell batteries.

### Note:

The preset settings such as pre-set channel and sound adjustment may be erased in the following cases:

- When you press **POWER** to set it in the **OFF** position.
- When you unplug the power cord.
- When a power failure occurs.

### CAUTIONS:

- Do not touch the power cord with wet hands.
- Do not pull on the power cord to unplug the receiver. When unplugging the receiver, always grasp the plug itself so as not to damage the cord.

### CAUTIONS:

- Follow these precautions to avoid leaking or cracking cells:
- Place batteries in the remote control so they match the polarity indicated: (+) to (+) and (-) to (-).
  - Use the correct type of batteries. Batteries that look similar may differ in voltage.
  - Always replace both batteries at the same time.
  - Do not expose batteries to heat or flame.

## Basic Operations

The following operations are commonly used when you play any sound source.

### Turning the Power On and Off (Standby)

#### On the front panel:

To turn on the power, press **STANDBY/ON**. The STANDBY lamp goes off. The name of the current source (or station frequency) appears on the display.



Current source name appears  
Current volume level is show here



To turn off the power (into standby mode), press **STANDBY/ON** again. The STANDBY lamp lights up.

#### From the remote control:

To turn on the power, press **AUDIO**. The STANDBY lamp goes off. The name of the current source (or station frequency) appears on the display.



To turn off the power (into standby mode), press **AUDIO** again. The STANDBY lamp lights up.

### Selecting the Source to Play

#### On the front panel:

1. Press **SOURCE** so that the **CONTROL**  $\Delta$  /  $\nabla$  /  $\leftarrow$  /  $\rightarrow$  button works for selecting the source. The lamp above the button lights up.
2. Press **CONTROL**  $\Delta$  /  $\nabla$  until the source name you want appears on the display.

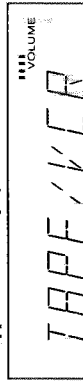

#### From the remote control:

Press one of the source buttons directly.

- TV SOUND** Listen to TV sounds.
- VCR1** View the video component connected to the VCR1 jacks.
- VIDEO** View the video component connected to the VIDEO jacks.
- TAPE/VCR\*** Listen to the cassette deck (or view the video component) connected to the TAPE/VCR jacks.
- CD\*** Listen to the CD player.
- FM/AM\*** Listen to an FM or AM (MW/LW) broadcast.

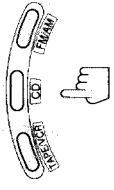

### Note:

When you press one of the source buttons on the remote control marked with an asterisk (\*), the receiver automatically turns on.



## Basic Operations

### Adjusting the Volume

**On the front panel:**  
To increase the volume, turn MASTER VOLUME clockwise.  
To decrease the volume, turn it counterclockwise.

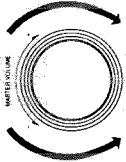

When you turn MASTER VOLUME rapidly, the volume level also changes rapidly.  
When you turn MASTER VOLUME slowly, the volume level also changes slowly.

### From the remote control:

To increase the volume, press VOLUME +.  
To decrease the volume, press VOLUME -.

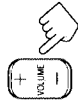

### Outputting the Sound through the Front Speakers

#### On the front panel only:

Press SPEAKERS to set it in the ON position.  
If you press it again to set it in the OFF position, no sound comes out of the front speakers.

#### CAUTION:

Be sure to turn down the volume before connecting or putting on headphones, as high volume can damage both the headphones and your hearing.

#### To listen only with headphones

1. Connect a standard pair of headphones to the PHONES jack on the front panel.
2. Press SPEAKERS to set it in the OFF position so that no sound comes out of the front speakers.

### Muting the Sound

#### From the remote control only:

Press MUTE to mute the sound through all speakers and headphones connected.  
"MUTE" appears on the display and the volume turns off.

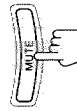

To restore the sound, press MUTE again so that "OFF" appears on the display.  
Turning MASTER VOLUME or pressing VOLUME +/- also restores the sound at the previous volume level.

### Recording a Source

You can record any source playing through the receiver to a cassette deck or VCR connected to the TAPE/VCR jacks and another VCR connected to the VCR1 jacks at the same time.  
While recording, you can listen to the selected sound source at whatever sound level you like, without affecting the sound levels of the recording.

## Basic Settings

Some of the following settings are required after connecting and positioning your speakers in your listening room, while others will make operations easier.

### Adjusting the Front Speaker Output Balance

If the sounds you hear from the front right and left speakers are unequal, you can adjust the speaker output balance.

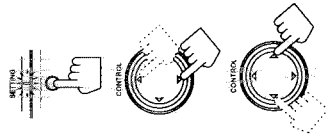

#### On the front panel only:

1. Press SETTING so that the CONTROL  $\Delta$  /  $\nabla$  /  $\triangleleft$  /  $\triangleright$  button works for adjusting the balance.  
The lamp above the button lights up.

2. Press CONTROL  $\Delta$  /  $\nabla$  until "BALANCE" appears on the display.

3. Press CONTROL  $\triangleleft$  /  $\triangleright$  to adjust the balance.

- Pressing CONTROL  $\triangleleft$  decreases the right channel output.
- Pressing CONTROL  $\triangleright$  decreases the left channel output.

### Listening at Low Volume (Loudness)

Human ears are not sensitive to bass at low volume. To compensate for this, the loudness function automatically boosts the bass level as you lower the volume.

#### On the front panel only:

1. Press SETTING so that the CONTROL  $\Delta$  /  $\nabla$  /  $\triangleleft$  /  $\triangleright$  button works for setting the loudness function.  
The lamp above the button lights up.
2. Press CONTROL  $\Delta$  /  $\nabla$  until "LOUDNESS" appears on the display.
3. Press CONTROL  $\triangleleft$  /  $\triangleright$  to set the loudness function to "ON" or "OFF":
  - Select "ON" to activate the loudness function.
  - The LOUDNESS indicator lights up on the display.
  - Select "OFF" to cancel it.
  - The indicator goes off.

### Using the Sleep Timer

Using the Sleep Timer, you can fall asleep to music and know the receiver will turn off by itself rather than play all night.

#### On the front panel only:

1. Press SETTING so that the CONTROL  $\Delta$  /  $\nabla$  /  $\triangleleft$  /  $\triangleright$  button works for setting the Sleep Timer.  
The lamp above the button lights up.
2. Press CONTROL  $\Delta$  /  $\nabla$  until "<SLEEP>" appears on the display.
3. Press CONTROL  $\triangleleft$  /  $\triangleright$  to set the shut-off time.  
Each time you press the button, the shut-off time on the display changes as follows, and the SLEEP indicator lights up on the display.

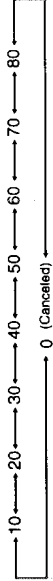

## Basic Settings

### When the shut-off time comes

The receiver turns off (into standby mode) automatically.

### To check or change the time remaining until the shut-off time

1. Press **SETTING**, if necessary, so that the **CONTROL**  $\Delta / \nabla / \triangleleft / \triangleright$  button works for setting the Sleep Timer.
2. Press **CONTROL**  $\Delta / \nabla$ , if necessary, until "**<SLEEP>**" appears on the display.
3. Press **CONTROL**  $\triangleleft / \triangleright$ .  
The remaining time until the shut-off time appears in minutes.
  - To change the shut-off time, press **CONTROL**  $\triangleleft / \triangleright$  repeatedly.

### To cancel the Sleep Timer

Press **CONTROL**  $\triangleleft / \triangleright$  repeatedly in step 3 above until "0" appears on the display. (The **SLEEP** indicator goes off.)  
Turning off the power (into standby mode) also cancels the Sleep Timer.

### Selecting the Center Speaker Size

You can register the information about the center speaker after all connections are completed.

If you do this registration first, you do not have to adjust the center speaker mode when you want to activate the surround sound.  
However, to register the information, first you have to set the surround mode, either to "PROLOGIC" or "3CHLOGIC." (You cannot select the center speaker size when the surround mode is off.)

### On the front panel only:

1. Press **SURROUND** so that the **CONTROL**  $\Delta / \nabla$  button works for selecting the surround/DAP mode.  
The lamp above the button lights up.
2. Press **CONTROL**  $\Delta / \nabla$  until "PROLOGIC" or "3CHLOGIC" appears on the display.  
The indicator of the selected mode also lights up on the display.
3. Press **SETTING** so that the **CONTROL**  $\Delta / \nabla / \triangleleft / \triangleright$  button works for selecting the center speaker size.  
The lamp above the button lights up.
4. Press **CONTROL**  $\Delta / \nabla$  until "CNTR SPK" (Center Speaker) appears on the display.
5. Press **CONTROL**  $\triangleleft / \triangleright$  to select the appropriate item about your center speaker.  
Each time you press the button, the display changes to show the following:  
 SMALL  $\longleftrightarrow$  LARGE  $\longleftrightarrow$  NO

<b>SMALL:</b>	Select this mode when the size of the center speaker is smaller than that of the front speakers.
<b>LARGE:</b>	Select this mode when the size of the center speaker is the same as that of the front speakers.
<b>NO:</b>	Select this mode when you don't use a center speaker. (You cannot select this mode when "3CHLOGIC" is selected.)

### Using Visual Confirmation

When you operate the receiver, you can see what you are doing by showing the on-screen menus (see pages 39 to 42) on the TV screen.  
To use this function, you need to connect the TV to the **MONITOR OUT** jack on the rear panel (see page 10), and set the TV's input mode to the proper position to which the receiver is connected.  
When the TV's input mode is for TV, you cannot see the on-screen menus.

### On the front panel:

1. Press **SETTING** so that the **CONTROL**  $\Delta / \nabla / \triangleleft / \triangleright$  button works for setting Visual Confirmation.  
The lamp above the button lights up.
2. Press **CONTROL**  $\Delta / \nabla$  until "VCONFIRM" appears on the display.

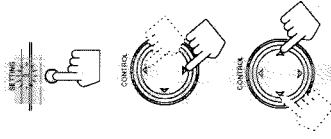

3. Press **CONTROL**  $\triangleleft / \triangleright$  to set Visual Confirmation to "ON" or "OFF."
  - Select "ON" to activate Visual Confirmation.  
The **VISUAL CONFIRMATION** indicator lights up on the display.
  - Select "OFF" to cancel it.  
The indicator goes off.

### EXAMPLES:

When you press **SOURCE**, then **CONTROL**  $\Delta / \nabla$  on the front panel, or one of the source buttons on the remote control:

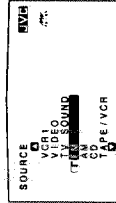

When you press **TUNER/BAND** then **CONTROL**  $\Delta / \nabla$  on the front panel, or press **FM/AM** on the remote control:

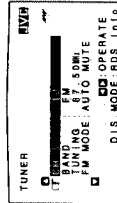

When you press **3D PHONIC** on the front panel, or press **3D-PHONIC ON/OFF** on the remote control:

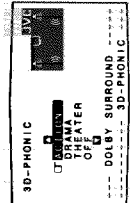

### Note:

If your TV is not of the PAL color system, the TV screen will lose its color.

# One Touch Operation

This receiver can memorize the optimum sound settings for each playing source.

## About the One Touch Operation

JVC's One Touch Operation function is used to assign and store different sound settings for each different playing source. By using this function, you don't have to change the settings every time you change the source. The stored settings for the newly selected source are automatically recalled.

The following can be stored for each source:

- Volume level (see page 13)
- Balance (see page 14)
- Loudness (see page 14)
- SEA modes (see page 26)
- 3D PHONIC mode settings (see page 29)
- DAP mode settings (see page 31)
- Surround mode settings (see page 34)

## Using the One Touch Operation

### To store the sound settings

1. **Press ONE TOUCH OPERATION.**  
The ONE TOUCH OPERATION lamp lights up, then the previously memorized settings are recalled and appear on the display in turn.
2. **Adjust the sound using the functions listed above.**  
The newly adjusted settings are memorized.



### To recall the sound settings

With the ONE TOUCH OPERATION lamp lit, the settings for the currently selected source is recalled, and appears on the display when the source is selected.

### To cancel the One Touch Operation function

Press ONE TOUCH OPERATION so that the lamp goes off.  
(Even though the One Touch Operation function is canceled, the recalled sound effects remain active.)



# Receiving Radio Broadcasts

You can browse through all the stations or use the preset function to go immediately to a particular station.

## Tuning in Stations Manually

### On the front panel only:

1. Press TUNER/BAND so that the CONTROL  $\Delta$  /  $\nabla$  /  $\triangleleft$  /  $\triangleright$  button works for tuner settings.  
The indicator above the button lights up.
2. Press CONTROL  $\Delta$  /  $\nabla$  until "<FM AM>" appears on the display.
3. Press CONTROL  $\triangleleft$  /  $\triangleright$  to select the band.  
When you press the button, the last received station of the selected band is tuned in.  
Each time you press the button, the band alternates between FM and AM (MW/LW).
4. Press CONTROL  $\Delta$  /  $\nabla$  until "<TUNING+>" appears on the display.
5. Press CONTROL  $\triangleleft$  /  $\triangleright$  until you find the frequency you want.
  - Pressing CONTROL  $\triangleleft$  decreases the frequency.
  - Pressing CONTROL  $\triangleright$  increases the frequency.

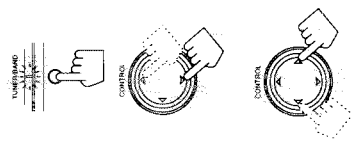

## Using Preset Tuning

Once a station is assigned to a channel number, the station can be quickly tuned. You can preset up to 40 stations at random.

### To store the preset stations

#### On the front panel only:

1. Tune in the station you want to preset (see above).  
If you want to store the FM reception mode for this station, select the FM reception mode you want. See page 20 for details.
2. Press MEMORY.  
"CH:" appears and the channel number position starts flashing on the display for about 5 seconds.
3. Press CONTROL  $\triangleleft$  /  $\triangleright$  to select a channel number while the channel number position is flashing.
  - Pressing CONTROL  $\triangleleft$  decreases the number.
  - Pressing CONTROL  $\triangleright$  increases the number.
4. Press MEMORY again while the selected channel number is flashing on the display.  
The selected channel number stops flashing.  
The station is assigned to the selected channel number.

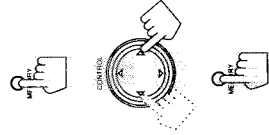

Continued on the next page.

### Notes:

- When you hold down CONTROL  $\triangleleft$  /  $\triangleright$  in step 5, the frequency keeps changing until you press CONTROL  $\triangleleft$  /  $\triangleright$  again or a station is tuned in.
- When a station of sufficient signal strength is tuned in, the TUNED indicator lights up on the display.  
When an FM stereo program is received, the STEREO indicator also lights up.

### CAUTION:

- The preset channels may be erased in the following cases:
  - When you press  $\text{POWER}$  set it in the OFF position.
  - When you unplug the power cord.
  - When a power failure occurs.

### Note:

- You can press 10 keys on the remote control to select a channel number in step 3 under the following conditions:
  - If you have pressed FM/AM prior to starting this preset procedure.
  - If you have set the NUMERIC/AUDIO CONTROL to NUMERIC.

For channel number 5, press 5.  
For channel number 15, press +10 then 5.  
For channel number 20, press +10 then 10.  
For channel number 30, press +10, +10, then 10.

## Receiving Radio Broadcast

- Repeat steps 1 to 4 until you store all the stations you want.

### To cancel a stored preset station

Storing a new station on a used number erases the previously stored one.

### To tune in a preset station

- If the One Touch Operation function is turned on, press ONE TOUCH OPERATION to cancel it temporarily.  
The ONE TOUCH OPERATION lamp goes off.
- Press TUNER/BAND so that the CONTROL  $\Delta$  /  $\nabla$  /  $\triangleleft$  /  $\triangleright$  button works for tuner settings.  
The lamp above the button lights up.
- Press CONTROL  $\Delta$  /  $\nabla$  until “-PRESFT+” appears on the display.
- Press CONTROL  $\triangleleft$  /  $\triangleright$  to select a preset channel.  
Each time you press the button, the preset channels changes.
  - Pressing CONTROL  $\triangleleft$  changes preset channels in decreasing order.
  - Pressing CONTROL  $\triangleright$  changes preset channels in increasing order.
- If you want to recall the memorized settings of the One Touch Operation function for the selected channel (see page 17), press ONE TOUCH OPERATION again.  
The ONE TOUCH OPERATION lamp lights up.

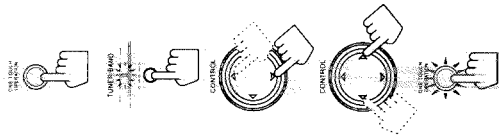

**Note:**  
With the One Touch Operation function turned on, the preset channel (1 to 20) does not appear on the display immediately while changing the preset channels. This is because the One Touch Operation function works and shows its stored settings before a preset channel number appears on the display.

### From the remote control:

- Press FM/AM.**  
The last received station of the last selected band is tuned in.  
Each time you press the button, the band alternates between FM and AM (MW/LW).
- Set the NUMERIC/AUDIO CONTROL selector to NUMERIC.**
- Press 10 keys to select a preset channel number.**
  - For channel number 5, press 5.
  - For channel number 15, press +10 then 5.
  - For channel number 20, press +10 then 10.
  - For channel number 30, press +10, +10, then 10.

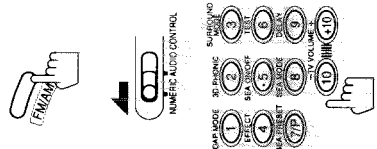

### Selecting the FM Reception Mode

You can change the FM reception mode while receiving an FM broadcast.

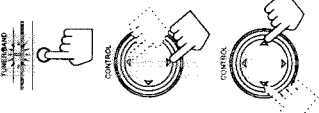

#### On the front panel only:

- Press TUNER/BAND so that the CONTROL  $\Delta$  /  $\nabla$  /  $\triangleleft$  /  $\triangleright$  button works for tuner settings.  
The lamp above the button lights up.
- Press CONTROL  $\Delta$  /  $\nabla$  until “<FM MODE>” appears on the display.
- Press CONTROL  $\triangleleft$  /  $\triangleright$  to select either “AUTO” or “MONO.”
  - Normally select “AUTO.”
  - When an FM stereo broadcast is hard to receive or noisy, select “MONO.”

<b>AUTO:</b>	When a program is broadcast in stereo, you will hear stereo sound; when in monaural, you will hear monaural sounds. This mode is also useful to suppress static noise between stations. The MUTE/AUTO indicator lights up on the display.
<b>MONO:</b>	Reception will be improved although you will lose the stereo effect. In this mode, you will hear noise while tuning into the stations. The MUTE/AUTO indicator goes off on the display.

### Using the RDS (Radio Data System) to Receive FM Stations

RDS allows FM stations to send an additional signal along with their regular program signals. For example, the stations send their station names, as well as information about what type of program they broadcast, such as sports or music, etc.

When tuned to an FM station which provides the RDS service, the RDS indicator lights up on the display.

With the receiver, you can receive the following types of RDS signals.

- PS (Program Service) : shows commonly known station names
- PTY (Program Type) : shows types of broadcast programs
- RT (Radio Text) : shows text messages the station sends

**Note:**

You can store the FM reception mode for each preset station.



**Note:**

RDS may not operate correctly if the station tuned is not transmitting data properly or if the signal strength is weak.



## Receiving Radio Broadcasts

### From the remote control:

Before starting the procedure below, make sure you have selected FM station only using the remote control. If not, the following RDS buttons do not work for tuner operation. (Pressing FM/AM activates the remote control for tuner operation.)

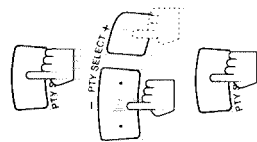

1. Press **PTY SEARCH** while listening to an FM station. "PTY" and "SELECT" alternate on the display.
2. Press **PTY SELECT +/-** until the **PTY** code you want appears on the display. The display gives you the PTY codes described below.
3. Press **PTY SEARCH** again. While searching, "SEARCH" and the selected PTY code alternate on the display. The receiver searches 40 preset channels, stops when it finds the one you have selected, and tunes in that station.

### To continue searching after the first stop:

Press **PTY SEARCH** again while the indications on the display are flashing. "NOTFOUND" appears on the display.



### To stop searching any time during the process:

Press **PTY SEARCH** while searching.

### Descriptions of the PTY codes:

<b>NEWS:</b>	News	NEWS	NEWS
<b>AFFAIRS:</b>	Topical programs expanding on the current news or affairs	ALARM	AFFAIRS
<b>INFO:</b>	Programs on medical service, weather forecast, etc.	OTHER M	INFO
<b>SPORT:</b>	Sports events	CLASSICS	SPORT
<b>EDUCATE:</b>	Educational programs	LIGHT M	EDUCATE
<b>DRAMA:</b>	Radio plays	M O R M	DRAMA
<b>CULTURE:</b>	Programs on national or regional culture	ROCK M	CULTURE
<b>SCIENCE:</b>	Programs on natural sciences and technology	POP M	SCIENCE
<b>VARIED:</b>	Other programs like comedies or ceremonies	VARIED	VARIED
<b>POP M:</b>	Pop music		
<b>ROCK M:</b>	Rock music		
<b>M O R M:</b>	Middle-of-the-road music (usually called "easy listening")		
<b>LIGHT M:</b>	Light music		
<b>CLASSICS:</b>	Classics		
<b>OTHER M:</b>	Other music		
<b>NONE:</b>	Undefined (this cannot be searched.)		
<b>ALARM:</b>	Emergency broadcasts		

### When an emergency broadcast (ALARM signal) is sent from an FM station:

The receiver automatically switches the source to FM and tunes in the station except in the following cases:

- When you are listening to non-RDS stations (all AM (MW/LW) and some FM stations).
- When the power is not supplied to the receiver.
- While receiving an emergency broadcast, "ALARM" appears on the display.

### Switching to a Broadcast Program of Your Choice Temporarily

Another convenient RDS service is called "EON (Enhanced Other Network)". This allows the receiver to switch temporarily to a broadcast program of your choice (NEWS, TA, and/or INFO) from a different station except in the following cases:

- When you are listening to a non-RDS station (all AM (MW/LW) and some FM stations).
- When the last received FM station is a non-RDS station.

### On the front panel only:

1. Press **EON** so that the last selected program type appears on the display.



2. Press **TA/NEWS/INFO** until the program type you want appears on the display.

Each time you press the button, the display changes to show the following.

The receiver enters EON standby mode.

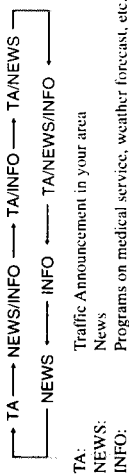

### Notes:

- In EON standby mode, if you change the source to AM or if you carry out synchronized recording (see page 43), EON standby mode is canceled temporarily. The receiver goes back to EON standby mode again when you have finished that operation.
- While listening to a program tuned in by the EON function, you can only use the **STANDBY/ON (OVI)**, **EON**, and **DISPLAY MODE** buttons on the front panel or the **AUDIO (OVI)** and **DISPLAY MODE** buttons on the remote control.
- When the receiver is turned off, the EON function is also turned off.

## Receiving Radio Broadcasts

### CASE 1 If there is no station broadcasting the program you have selected

The receiver continues playing the current source.



When a station starts broadcasting the program you have selected, the receiver automatically switches to the station. The indicator of received PTY code starts flashing.



When the program is over, the receiver goes back to the previously selected source, but still remains in EON standby mode.

### CASE 2 If there is a station broadcasting the program you have selected

The receiver stops playing the current source, and tunes in the program. The indicator of received PTY code starts flashing.



When the program is over, the receiver goes back to the previously selected source, but still remains in EON standby mode.

### To stop listening to the program selected by EON:

Press EON until the program type (TA/NEWS/INFO)

goes off from the display.

The receiver enters EON off mode and goes back to the previously selected source.



### Note:

When the source alternates intermittently between the station tuned in by the EON function and the currently selected source, press EON to cancel the EON function. This is not a malfunction of the receiver.

## Using the Preset SEA Modes

The preset SEA (Sound Effect Amplifier) modes give you control over the way your music sounds.

### Selecting Your Favorite SEA Mode

#### On the front panel:

1. Press PRESET SEA so that the CONTROL  $\Delta / \nabla / \triangleleft / \triangleright$  button works for preset SEA setting.

The lamp above the button lights up.

2. Press CONTROL  $\Delta / \nabla$  until the mode you want appears on the display.

Each time you press the button, the preset SEA modes change as follows:

MOVIE  $\longleftrightarrow$  SPORTS  $\longleftrightarrow$  MUSIC  $\longleftrightarrow$  OFF

The lamp of the selected preset SEA mode lights up in turn as you select the preset SEA modes.

3. Press CONTROL  $\triangleleft / \triangleright$  to select the effect level.

Each time you press the button, the effect level changes as follows:

When "MOVIE" is selected:

MOVIE 1  $\longleftrightarrow$  MOVIE 2  $\longleftrightarrow$  MOVIE 3

When "SPORTS" is selected:

SPORTS1  $\longleftrightarrow$  SPORTS2  $\longleftrightarrow$  SPORTS3

When "MUSIC" is selected:

JAZZ 1  $\longleftrightarrow$  JAZZ 2  $\longleftrightarrow$  ROCK 1  $\longleftrightarrow$  ROCK 2  $\longleftrightarrow$  COUNTRY2  $\longleftrightarrow$  COUNTRY1  $\longleftrightarrow$  MUSICAL2  $\longleftrightarrow$  MUSICAL1

<b>MOVIE:</b>	Adds breadth to sounds so you feel like you are in a movie theater.
<b>SPORTS:</b>	Makes sounds exciting.
<b>MUSIC:</b>	Select one of the modes below.
<b>JAZZ:</b>	Gives a feeling of a live atmosphere. Good for acoustic music.
<b>ROCK:</b>	Gives a heavy sound. Both high and low frequencies are boosted.
<b>MUSICAL:</b>	Enhances the mid-frequency range, which the human voice is mostly made up of.
<b>COUNTRY:</b>	Enhances the high-frequency range so that instruments such as the violin and banjo are emphasized.
<b>OFF:</b>	No preset SEA mode is applied (also see below).

### To simply turn the preset SEA mode on or off

You can turn on and off the preset SEA mode, by simply pressing MOVIE, SPORTS, or MUSIC.

The lamp of the selected mode lights up when it is on, and goes off when it is off.



### Notes:

- The preset SEA mode cannot be used for recording.
- When you turn on the preset SEA mode, the mode and its effect level previously selected is recalled at first.
- While you are selecting a preset SEA mode, the corresponding lamp lights up in turn.

### Notes:

- When you turn on the preset SEA mode, the mode is recalled at its previous effect level.
- Selecting another mode cancels the one previously selected.

## Using the Preset SEA Modes

### From the remote control:

1. Set the **NUMERIC/AUDIO CONTROL** selector to **AUDIO CONTROL**.

2. Press **SEA ON/OFF** so that one of the preset **SEA mode lamps (MUSIC, SPORTS, MOVIE)** lights up. The previous mode is recalled (at its previous effect level) and is shown on the display.

Each time you press the button, the preset SEA mode turns on and off.

3. Press **SEA MODE** until the mode you want appears on the display.  
Each time you press the button, the preset SEA modes change as follows:

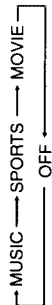

The lamp of each selected preset SEA mode lights up in turn as you select the preset SEA modes.

4. Press **SEA PRESET** to select the effect level.

Each time you press the button, the effect level changes as follows:

When "MUSIC" is selected:

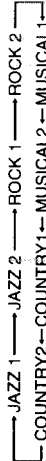

When "SPORTS" is selected:

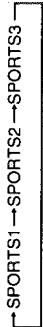

When "MOVIE" is selected:



### To cancel the preset SEA mode

Press **SEA ON/OFF** again (with the **NUMERIC/AUDIO CONTROL** selector set to **AUDIO CONTROL**) so that the indicator of the selected mode goes off. Selecting "OFF" in step 3 above also cancels the preset SEA mode.



## Using the Surround Processor

The built-in surround processor provides three types of the surround modes — **JVC's 3D PHONIC mode**, **DAP (Digital Acoustic Processor) mode**, and **Dolby Surround**.

### On JVC's 3D PHONIC mode

JVC's 3D PHONIC mode gives you such a nearly surround effect as it is reproduced through the Dolby Surround decoder, which is widely used to reproduce sounds with a feeling of movement like those experienced in movie theaters. JVC's 3D PHONIC mode is the result of research on sound localization technology carried out at JVC for many years and makes it possible to reproduce the surround sound with only two front speakers.

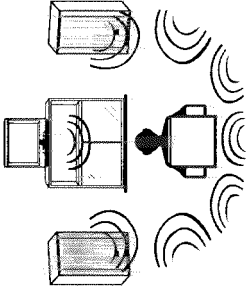

### On the DAP mode

The sound heard in a concert hall or club consists of direct sound and indirect sound — early reflections and reflections from behind. Direct sounds reach the listener directly without any reflection. On the other hand, indirect sounds are delayed by the distances of the ceiling and walls. These direct sounds and indirect sounds are the most important elements of the acoustic surround effects. The DAP mode can create these important elements, and gives you a real "being there" feeling by using both the front speakers and rear speakers.

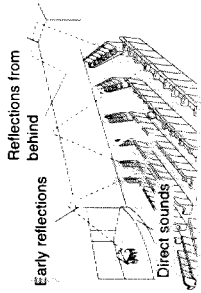

### On Dolby Surround

Dolby Surround has been developed to reproduce the important elements of the acoustic surround at home. To watch the soundtracks of video software bearing the mark  \* which includes the same encoded surround information as found in Dolby Stereo films, the receiver can provide you with 2 Dolby Surround modes (Dolby Pro Logic and Dolby 3ch Logic).

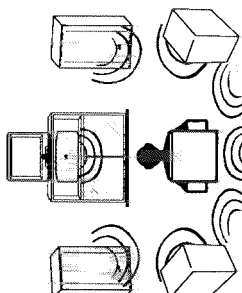

**Dolby Pro Logic:** Select this mode when optional center and rear speakers are connected.

**Dolby 3ch Logic:** Select this mode when a center speaker is connected without rear speakers.

### Notes:

- The surround processor has no effect on monaural sources.
- The surround processor cannot be used for recording.

\* Manufactured under license from Dolby Laboratories Licensing Corporation. "Dolby," the double-D symbol, and "Pro Logic" are trademarks of Dolby Laboratories Licensing Corporation.





# Using the Surround Processor

## Using JVC's 3D PHONIC Modes

When using JVC's 3D PHONIC modes, you need only two front speakers to reproduce the soundtracks of video software bearing the mark . The 3D PHONIC modes gives you a very realistic surround effect when the sound is reproduced through the Dolby Surround decoder.

### On the front panel:

1. Press 3D PHONIC so that the lamp lights up.  
The 3D-PHONIC indicator also lights up on the display.  
Each time you press the button, the 3D PHONIC modes change as follows:  

2. Press ADJUST so that the CONTROL </> / > button works for adjusting the effect level.  
The lamp above the button lights up, and "EFFECT+" appears on the display.  

3. Press CONTROL </> / > to adjust the effect level.  
Each time you press the button, the effect level changes as follows:  

As the number increases, the selected 3D PHONIC mode becomes stronger.

4. Select and play a sound source which was processed with Dolby Surround and is labeled with  mark.

### To cancel the 3D PHONIC mode

Press 3D PHONIC repeatedly until "OFF" appears and the 3D-PHONIC indicator goes off.





### Note:

The 3D PHONIC mode is not used with other surround modes such as Dolby Surround and The DAP modes. When the 3D PHONIC mode is turned on, the other surround mode, if used, will be turned off.

### Note:

Once you have adjusted the effect level, it is memorized for each 3D PHONIC mode.

### From the remote control:

1. Set the NUMERIC/AUDIO CONTROL selector to AUDIO CONTROL.  

  2. Press 3D-PHONIC ON/OFF so that the 3D-PHONIC indicator lights up on the display.  
The previous mode is recalled (at its previous effect level) and is shown on the display.  
Each time you press the button, the 3D PHONIC mode turns on and off.  

  3. Press 3D-PHONIC until the mode you want appears on the display.  
Each time you press the button, the 3D PHONIC modes change as follows:  

  4. Press EFFECT to select the effect level.  
Each time you press the button, the level changes as follows:  

- As the number increases, the selected 3D PHONIC mode becomes stronger.
5. Select and play a sound source which was processed with Dolby Surround and is labeled with  mark.

### To cancel the 3D PHONIC mode

Press 3D-PHONIC ON/OFF again (with the NUMERIC/AUDIO CONTROL selector set to AUDIO CONTROL) so that "OFF" appears and the 3D-PHONIC indicator goes off.

### Note:

When you turn on the 3D PHONIC mode, one of the modes previously selected is recalled at first.

### Note:

Once you have adjusted the effect level, it is memorized for each 3D PHONIC mode.

# Using the Surround Processor

## Using the DAP Modes

You can use five DAP modes — "Dance Club, Live Club, Hall, Pavilion, and Headphones." These modes (except "Headphones") require the front speakers and the rear speakers, but do not require a center speaker to enlarge the sound field.

Among the DAP modes, "Headphones" is very special. It can create the same stereo sound as you listen through the speakers off air while listening to a source using headphones. So, you can feel as if you were not using the headphones and listening to music in a room.

### On the front panel:

1. Press **SURROUND** so that the **CONTROL**  $\Delta / \nabla$  button works for selecting the surround/DAP modes. The lamp above the button lights up.

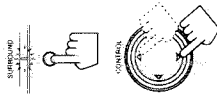

2. Press **CONTROL**  $\Delta / \nabla$  until the mode you want appears on the display.

The DAP indicator also lights up on the display. Each time you press the button, the surround/DAP modes change as follows:

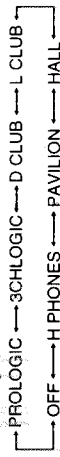

<b>PROLOGIC:</b>	See pages 33 to 38.
<b>3CHLOGIC:</b>	See pages 33 to 38.
<b>Dance CLUB</b>	Gives a throbbing bass beat.
<b>Live CLUB</b>	Gives the feeling of a live music club with a low ceiling.
<b>HALL</b>	Gives clear vocal and the feeling of a concert hall.
<b>PAVILION</b>	Gives the spacious feeling of a pavilion with a high ceiling.
<b>Headphones*</b>	Gives a spacious stereo effect when listening with headphones.
<b>OFF</b>	No surround/DAP mode is applied.

3. Press **ADJUST** so that the **CONTROL**  $\Delta / \nabla / \triangleleft / \triangleright$  button works for adjusting the selected mode. The lamp above the button lights up.

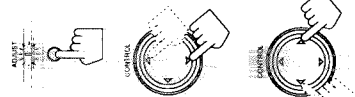

4. Press **CONTROL**  $\Delta / \nabla$  until "REAR +" appears on the display.
5. Press **CONTROL**  $\triangleleft / \triangleright$  to adjust the rear speaker output level. Pressing **CONTROL**  $\triangleleft$  decreases the output level up to -10 dB. Pressing **CONTROL**  $\triangleright$  increases the output level up to +10 dB.

6. Press **CONTROL**  $\Delta / \nabla$  until "EFFECT +" appears on the display.

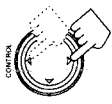

7. Press **CONTROL**  $\triangleleft / \triangleright$  to adjust the effect level. Each time you press the button, the effect level changes as follows:



As the number increases, the selected DAP mode becomes stronger.

### To cancel the surround/DAP mode

Select "OFF" in step 2. The DAP indicator goes off from the display.

### From the remote control:

1. Set the **NUMERIC/AUDIO CONTROL** selector to **AUDIO CONTROL**.



2. Press **DAP ON/OFF** so that the DAP indicator lights up on the display.

The previous mode is recalled (at its previous effect level) and is shown on the display. Each time you press the button, the DAP mode turns on and off.

**Note:**  
When you turn on the DAP mode, one of the modes previously selected is recalled at first.

3. Press **DAP MODE** until the mode you want appears on the display.

Each time you press the button, the DAP modes change as follows:

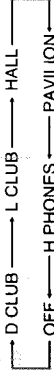

4. Press **REAR +/-** to adjust the rear speaker output level. Pressing **REAR -** decreases the output level up to -10 dB. Pressing **REAR +** increases the output level up to +10 dB.



5. Press **EFFECT** to select the effect level.

Each time you press the button, the level changes as follows:



### To cancel the DAP mode

Press **DAP ON/OFF** again (with the **NUMERIC/AUDIO CONTROL** selector set to **AUDIO CONTROL**) so that "OFF" appears and the DAP indicator goes off.

**Note:**  
Once you have adjusted the DAP modes, the adjustment is memorized for each DAP mode.

# Using the Surround Processor

## Speakers Arrangements for Dolby Surround

The following illustrations show how to obtain the optimum sound environment for various Dolby Surround settings. Try to find the speaker direction and location to create the optimum sound field.

### CASE 1 When you have added a center speaker and rear speakers

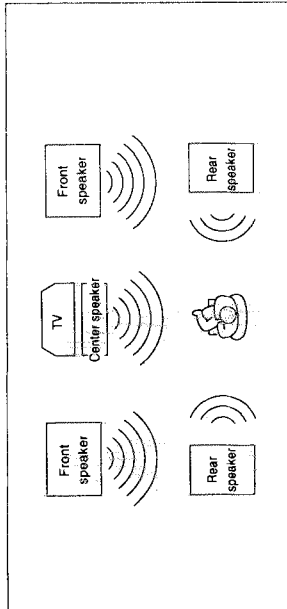

### CASE 2 When you have added rear speakers (without a center speaker)

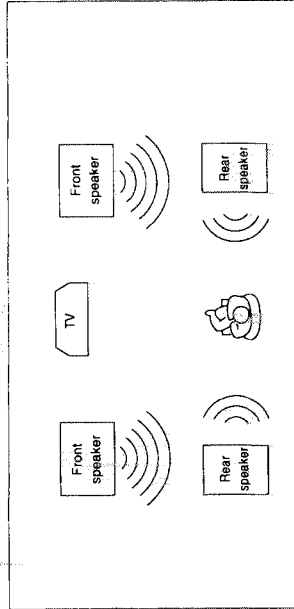

### CASE 3 When you have added a center speaker (without rear speakers)

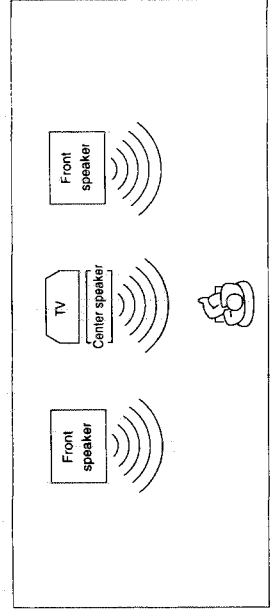

## Preparing for Dolby Surround

The receiver memorizes two sets of Dolby Surround adjustments; one for Pro Logic and the other for 3ch Logic.

### On the front panel:

1. Press **SURROUND** so that the **CONTROL** Δ / ▽ button works for selecting the surround/DAP modes. The lamp above the button lights up.
2. Press **CONTROL** Δ / ▽ until "PROLOGIC" or "3CHLOGIC" whichever you want appears on the display. The PRO LOGIC or 3CH LOGIC indicator also lights up.

Each time you press the button, the surround/DAP modes change as follows:

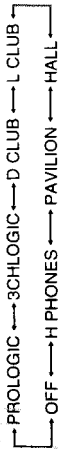

<b>PROLOGIC</b>	Select this mode when you use a center speaker and rear speakers.
<b>3CHLOGIC</b>	Select this mode when you use a center speaker without rear speakers.
<b>OFF</b>	Select this to turn off the surround mode.

\* For the other modes, see page 31.

3. Press **ADJUST** so that the **CONTROL** Δ / ▽ / ◀ / ▶ button works for adjusting the selected surround mode. The lamp above the button lights up.

4. Press **CONTROL** Δ / ▽ until "CNT MODE" (Center Mode) appears on the display.

Continued on the next page.

### In this case:

1. Select "PROLOGIC."
2. Select "NORMAL" or "WIDE" for center mode.

See pages 34 to 37 for more details.

### In this case:

1. Select "PROLOGIC."
2. Select "PHANTOM" for center mode.

See pages 34 to 37 for more details.

### In this case:

1. Select "3CHLOGIC."
2. Select "NORMAL" or "WIDE" for center mode.

See pages 34 to 37 for more details.

# Using the Surround Processor

## 5. Press CONTROL $\Delta$ / $\nabla$ to select the center mode.

Each time you press the button, the center modes change as follows:

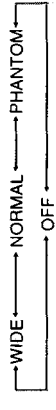

<b>WIDE</b>	Select this mode when the center speaker can reproduce the bass better than the front speakers. All signals of the center channel are output through the center speaker.
<b>NORMAL</b>	Select this mode when the center speaker cannot reproduce the bass better than the front speakers. The bass portions of the center channel signals are output through the front speakers.
<b>PHANTOM</b>	Select this mode when you do not use a center speaker. The center speaker channel signals are output through the front speakers.
<b>OFF</b>	Select this mode to turn off the center speaker channel.

## 6. Press CONTROL $\Delta$ / $\nabla$ until “-DELAY +” appears on the display.

## 7. Press CONTROL $\Delta$ / $\nabla$ to adjust the delay time of the rear speaker output.

Each time you press the button, the delay time changes as follows:



<b>DELAY 1</b>	Select this when the distance from you to your rear speakers is greater than that to the front speakers.
<b>DELAY 2</b>	Select this when the distance from you to your rear speakers is almost equal to that to the front speakers.
<b>DELAY 3</b>	Select this when the distance from you to your rear speakers is less than that to the front speakers.

## 8. Press CONTROL $\Delta$ / $\nabla$ until “TEST” appears on the display, then press CONTROL $\Delta$ / $\nabla$ to start checking the speaker output balance.

“TEST” starts flashing on the display, and a test tone comes out of the speakers in the following order:

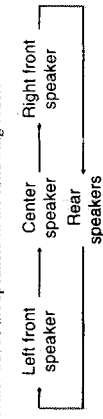

### Notes:

- If you have already set the center speaker size following the procedure described on page 15, you do not have to select the center mode in this procedure.
- When you have selected “3CHLOGIC,” you cannot select “PHANTOM.”

### Note:

When you have selected “3CHLOGIC,” you cannot adjust the delay time.

### Notes:

- No test tone comes out of the rear speakers when you have selected “3CHLOGIC.”
- No test tone comes out of the center speaker when you select “PHANTOM” or “OFF” for the center mode.

## 9. If necessary, adjust the speaker output balance as follows:

- To adjust the rear speaker output level, press CONTROL  $\Delta$ / $\nabla$  until “-REAR +” appears on the display, then press CONTROL  $\Delta$ / $\nabla$ .
- To adjust the center speaker output level, press CONTROL  $\Delta$ / $\nabla$  until “-CENTER+” appears on the display, then press CONTROL  $\Delta$ / $\nabla$ .

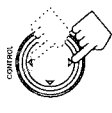

## 10. Press CONTROL $\Delta$ / $\nabla$ until “TEST” appears on the display, then press CONTROL $\Delta$ / $\nabla$ to stop the test tone.

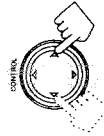

### From the remote control:

If you have already set the center speaker size following the procedure described on page 15, you can use the remote control for Dolby Surround preparation.



## 1. Set the NUMERIC/AUDIO CONTROL selector to AUDIO CONTROL.

## 2. Press SURROUND ON/OFF so that either the PRO LOGIC or 3CH LOGIC indicator lights up on the display.

The previous mode is recalled (at its previous settings) and is shown on the display. Each time you press the button, the surround mode turns on and off.



## 3. Press SURROUND MODE until the mode you want appears on the display.

Each time you press the button, the surround modes change as follows:

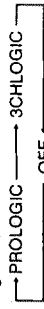

## 4. Press DELAY to adjust the delay time of the rear speaker output.

Each time you press the button, the delay time changes as follows:



## 5. Press TEST to start checking the speaker output balance.

“TEST” starts flashing on the display, and a test tone comes out of the speakers in the following order:

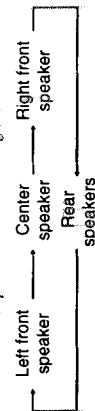

### Notes:

- The sound levels of the left and right rear speakers will be the same.
- You cannot set the sound level of the rear speakers when you have selected “3CHLOGIC.”
- You cannot set the sound level of the center speaker when you select “PHANTOM” or “OFF” for the center mode.

### Note:

When you have selected “3CHLOGIC,” you cannot adjust the delay time.

### Notes:

- No test tone comes out of the rear speakers when you have selected “3CHLOGIC.”
- No test tone comes out of the center speaker when you select “PHANTOM” or “OFF” for the center mode.

Continued on the next page.

## Using the Surround Processor

### 6. If necessary, adjust the speaker output balance as follows:

- To adjust the rear speaker output level, press REAR +/-
- To adjust the center speaker output level, press CENTER +/-.

Pressing - decreases the output level up to -10 dB.  
Pressing + increases the output level up to +10 dB.

### 7. Press TEST again to stop the test tone.



### Notes:

- The sound levels of the left and right rear speakers will be the same.
- You cannot set the sound level of the rear speakers when you have selected "3CHLOGIC."
- You cannot set the sound level of the center speaker when you select "PHANTOM" or "OFF" for the center mode.

### Using Dolby Surround

Once you have set the Dolby Surround adjustments you can use the same adjustments every time you want to activate Dolby Surround.

#### From the front panel:

- Press SURROUND so that the CONTROL  $\Delta / \nabla$  button works for selecting the surround/DAP modes. The lamp above the button lights up.



- Press CONTROL  $\Delta / \nabla$  until "PROLOGIC" or "3CHLOGIC" whichever you want appears on the display. The PRO LOGIC or 3CH LOGIC indicator also lights up. Each time you press the button, the surround/DAP modes change as follows:

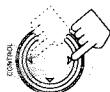

PROLOGIC  $\leftrightarrow$  3CHLOGIC  $\leftrightarrow$  D CLUB  $\leftrightarrow$  L CLUB  $\leftrightarrow$  HALL  
OFF  $\leftrightarrow$  H PHONES  $\leftrightarrow$  PAVILION  $\leftrightarrow$  HALL

- Select and play a sound source which was processed with Dolby Surround and is labeled with  mark.

#### To cancel Dolby Surround

Select "OFF" in step 2 above. The indicator of the selected mode goes off.

#### From the remote control:

- Set the NUMERIC/AUDIO CONTROL selector to AUDIO CONTROL.





- Press SURROUND ON/OFF so that either the PRO LOGIC or 3CH LOGIC indicator lights up on the display. The previous mode is recalled (at its previous settings) and is shown on the display. Each time you press the button, the surround mode turns on and off.

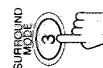

- If necessary, press SURROUND MODE until the mode you want appears on the display. Each time you press the button, the surround modes change as follows:

PROLOGIC  $\leftrightarrow$  OFF  $\leftrightarrow$  3CHLOGIC



- Select and play a sound source which was processed with Dolby Surround and is labeled with  mark.

#### To cancel Dolby Surround

Press SURROUND ON/OFF again (with the NUMERIC/AUDIO CONTROL selector set to AUDIO CONTROL) so that the indicator of the selected mode goes off. Selecting "OFF" in step 3 above also cancels the Dolby Surround.

# Using the On-Screen Menus

You can use the Menus on the TV screen to control the receiver. To use this function, you need to connect the TV to the MONITOR OUT jack on the rear panel (see page 10), and set the TV's input mode to the proper position to which the receiver is connected.

## Basic Procedures

### From the remote control:

- Press MENU SET.**  
The MAIN MENU appears on the TV screen.
  - If you press ON SCREEN CONTROL  $\Delta / \nabla / \leftarrow / \rightarrow$ , a sub-menu you can adjust at that time appears on the TV screen instead of the MAIN MENU.
- Press ON SCREEN CONTROL  $\Delta / \nabla$  to move  $\leftarrow$  to the sub-menu you want to set, then press  $\leftarrow / \rightarrow$ .  
The sub-menu you want appears.
- If necessary, press ON SCREEN CONTROL  $\Delta / \nabla / \leftarrow / \rightarrow$  to set or adjust the item you want on the selected sub-menu.
- When you finish, press MENU EXIT.  
The menu disappears from the TV.

To go back to the MAIN MENU any time during the process Press MENU SET.

### Selecting the Source to Play (Also see page 12)

- Press MENU SET.  
The MAIN MENU appears on the TV.
- Press ON SCREEN CONTROL  $\Delta / \nabla$  to move  $\leftarrow$  to "SOURCE," then press  $\leftarrow / \rightarrow$ .  
The SOURCE menu appears.
- Press ON SCREEN CONTROL  $\Delta / \nabla$  to move  $\leftarrow$  to the source you want to play.

### Adjusting the Front Speaker Output Balance (Also see page 14)

- Press MENU SET.  
The MAIN MENU appears on the TV.
- Press ON SCREEN CONTROL  $\Delta / \nabla$  to move  $\leftarrow$  to "SETTING," then press  $\leftarrow / \rightarrow$ .  
The SETTING menu appears.
- Press ON SCREEN CONTROL  $\Delta / \nabla$  to move  $\leftarrow$  to "BAL" (Balance).
- Press ON SCREEN CONTROL  $\leftarrow / \rightarrow$  repeatedly to adjust the balance.



Shows the buttons you can use on the current menu. In this case, use  $\Delta / \nabla$  to move  $\leftarrow$  up and down, and  $\leftarrow / \rightarrow$  to select the item.

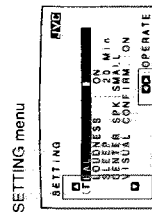
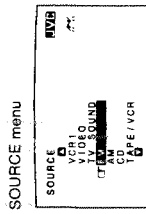

Shows the buttons you can use on the current menu. In this case, use  $\Delta / \nabla$  to move  $\leftarrow$  up and down, and  $\leftarrow / \rightarrow$  to adjust or set the item.

**Note:**  
If your TV is not of the PAL color system, the TV screen will be distorted.

### Listening at Low Volume (Loudness) (Also see page 14)

- Press MENU SET.  
The MAIN MENU appears on the TV.
- Press ON SCREEN CONTROL  $\Delta / \nabla$  to move  $\leftarrow$  to "SETTING," then press  $\leftarrow / \rightarrow$ .  
The SETTING menu appears.
- Press ON SCREEN CONTROL  $\Delta / \nabla$  to move  $\leftarrow$  to "LOUDNESS."
- Press ON SCREEN CONTROL  $\leftarrow / \rightarrow$  to turn the loudness "ON" or "OFF."

### Using the Sleep Timer (Also see page 14)

- Press MENU SET.  
The MAIN MENU appears on the TV.
- Press ON SCREEN CONTROL  $\Delta / \nabla$  to move  $\leftarrow$  to "SETTING," then press  $\leftarrow / \rightarrow$ .  
The SETTING menu appears.
- Press ON SCREEN CONTROL  $\Delta / \nabla$  to move  $\leftarrow$  to "SLEEP."
- Press ON SCREEN CONTROL  $\leftarrow / \rightarrow$  to set the shut-off time.

### Selecting the Center Speaker Size (Also see page 15)

- Press MENU SET.  
The MAIN MENU appears on the TV.
- Press ON SCREEN CONTROL  $\Delta / \nabla$  to move  $\leftarrow$  to "SETTING," then press  $\leftarrow / \rightarrow$ .  
The SETTING menu appears.
- Press ON SCREEN CONTROL  $\Delta / \nabla$  to move  $\leftarrow$  to "CENTER SPK" (Center Speaker).
- Press ON SCREEN CONTROL  $\leftarrow / \rightarrow$  repeatedly until the appropriate center speaker size is selected.

### Using Visual Confirmation (Also see page 16)

- Press MENU SET.  
The MAIN MENU appears on the TV.
- Press ON SCREEN CONTROL  $\Delta / \nabla$  to move  $\leftarrow$  to "SETTING," then press  $\leftarrow / \rightarrow$ .  
The SETTING menu appears.
- Press ON SCREEN CONTROL  $\Delta / \nabla$  to move  $\leftarrow$  to "VISUAL CONFIRM." (Visual Confirmation).
- Press ON SCREEN CONTROL  $\leftarrow / \rightarrow$  to turn Visual Confirmation "ON" or "OFF."

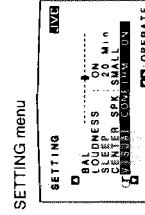
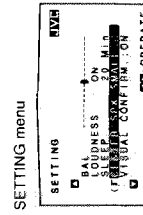
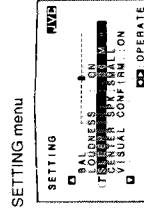
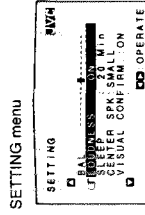

## Using the On-Screen Menus

### ■ Operating the Tuner

1. Press **MENU SET**.  
The MAIN MENU appears on the TV.
  2. Press **ON SCREEN CONTROL**  $\Delta$  /  $\nabla$  to move  $\square$  to "TUNER," then press  $\triangleleft$  /  $\triangleright$ .  
The TUNER menu appears.
  3. Press **ON SCREEN CONTROL**  $\Delta$  /  $\nabla$  to move  $\square$  to the item you want to set or adjust, then press **ON SCREEN CONTROL**  $\triangleleft$  /  $\triangleright$ .  
On the TUNER menu, you can do the following:  
"CH": Select a preset channel station. (See page 19)  
"BAND": Select the band. (See page 18)  
"TUNING": Tune in a station manually. (See page 18)  
"FM MODE": Select the FM reception mode. (See page 20)
- ### ■ Checking the RDS information
- (Also see page 21)
1. Press **MENU SET**.  
The MAIN MENU appears on the TV.
  2. Press **ON SCREEN CONTROL**  $\Delta$  /  $\nabla$  to move  $\square$  to "TUNER," then press  $\triangleleft$  /  $\triangleright$ .  
The TUNER menu appears.

### 3. Press **DISPLAY MODE**.

The RDS Information menu appears on the TV.

- \* Make sure that the **DISPLAY (MODE)** button is activated for tuner operation. (Pressing **FM/AM** activates the remote control for tuner operation.)

4. Press **ON SCREEN CONTROL**  $\Delta$  /  $\nabla$  /  $\triangleleft$  /  $\triangleright$  to move  $\square$  to go back to the TUNER menu.

### ■ Selecting Your Favorite SEA Mode

(Also see page 26)

1. Press **MENU SET**.  
The MAIN MENU appears on the TV.
2. Press **ON SCREEN CONTROL**  $\Delta$  /  $\nabla$  to move  $\square$  to "SEA," then press  $\triangleleft$  /  $\triangleright$ .  
The PRESET SEA menu appears.
3. Press **ON SCREEN CONTROL**  $\Delta$  /  $\nabla$  to move  $\square$  to the preset SEA mode you want.
4. Press **ON SCREEN CONTROL**  $\triangleleft$  /  $\triangleright$  to move  $\square$  to select the effect level (VARIATION) of the selected mode, if you want.

### ■ Using JVC's 3D PHONIC Modes

(Also see page 29)

1. Press **MENU SET**.  
The MAIN MENU appears on the TV.
2. Press **ON SCREEN CONTROL**  $\Delta$  /  $\nabla$  to move  $\square$  to "3D-PHONIC," then press  $\triangleleft$  /  $\triangleright$ .  
The 3D-PHONIC menu appears.

### TUNER menu

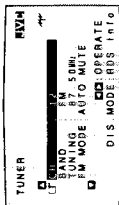

### RDS Information menu



### Note:

The on-screen display cannot show accented letters.

### PRESET SEA menu

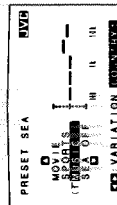
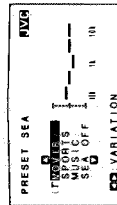

### 3D-PHONIC menu

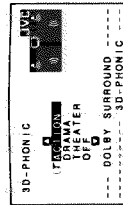

3. Press **ON SCREEN CONTROL**  $\Delta$  /  $\nabla$  to move  $\square$  to the 3D PHONIC mode you want.

Go to the next steps only when you want to adjust the selected mode.

4. Press **MENU SET** to go back to the MAIN MENU.  
The MAIN MENU appears again.
5. Press **ON SCREEN CONTROL**  $\Delta$  /  $\nabla$  to move  $\square$  to "3D/SURR/DAP ADJUST," then press  $\triangleleft$  /  $\triangleright$ .  
The adjustment menu of the selected 3D PHONIC mode appears.
6. Press **ON SCREEN CONTROL**  $\triangleleft$  /  $\triangleright$  to adjust the effect level.

### ■ Using the Surround or DAP Modes

(Also see pages 31 and 34)

1. Press **MENU SET**.  
The MAIN MENU appears on the TV.
2. Press **ON SCREEN CONTROL**  $\Delta$  /  $\nabla$  to move  $\square$  to "SURR/DAP," then press  $\triangleleft$  /  $\triangleright$ .  
The SURROUND/DAP menu appears.
3. Press **ON SCREEN CONTROL**  $\Delta$  /  $\nabla$  to move  $\square$  to the surround or DAP mode you want.

Go to the next steps only when you want to adjust the selected mode.

4. Press **MENU SET** to go back to the MAIN MENU.  
The MAIN MENU appears again.

5. Press **ON SCREEN CONTROL**  $\Delta$  /  $\nabla$  to move  $\square$  to "3D/SURR/DAP ADJUST," then press  $\triangleleft$  /  $\triangleright$ .  
The adjustment menu of the selected surround or DAP mode appears.

6. Press **ON SCREEN CONTROL**  $\Delta$  /  $\nabla$  to move  $\square$  to the item you want to set or adjust, then press **ON SCREEN CONTROL**  $\triangleleft$  /  $\triangleright$ .  
On these adjustment menus, you can do the following:

#### For Dolby Pro Logic:

"CENTER MODE": Select the center mode.

"TEST": Output a test tone.

"CENTER": Adjust the center speaker output level.

"REAR": Adjust the rear speaker output level.

"DELAY": Adjust the delay time of the rear speaker sound.

#### For Dolby 3ch Logic:

"CENTER MODE": Select the center mode.

"TEST": Output a test tone.

"CENTER": Adjust the center speaker output level.

For DAP modes (DANCE CLUB, LIVE CLUB, HALL, PAVILION):

"REAR": Adjust the rear speaker output level.

"EFFECT": Adjust the effect level.

### Ex. ACTION adjustment menu

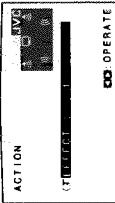

### SURROUND/DAP menu

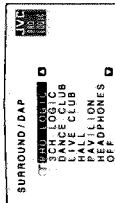

### Note:

When you select "HEAD-PHONES," you cannot go to steps 5 and 6.

### PRO LOGIC adjustment menu

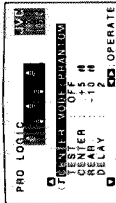

### 3CH LOGIC adjustment menu

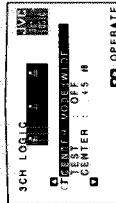

### Ex. DANCE CLUB adjustment menu

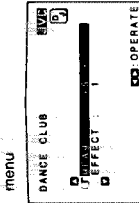

## COMPU LINK Remote Control System

The COMPU LINK remote control system allows you to operate JVC audio components through the remote sensor on the receiver.

To use this remote control system, you need to connect JVC audio components through the COMPU LINK-3 (SYNCHRO) jacks with the cable (monaural mini-plug supplied with those components):

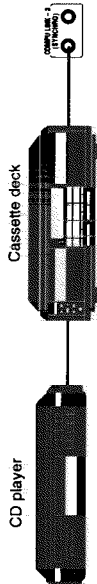

This remote control system allows you to use the four functions listed below.

### Remote Control through the Remote Sensor on the Receiver

You can control JVC audio components through the remote sensor on the receiver using this remote control. Aim the remote control directly at the remote sensor on the receiver. For details, see page 44.

### Automatic Source Selection

When you press the play (▶) button on a connected component or on its own remote control, the receiver automatically turns on and changes its source to the component. On the other hand, if you select a new source on the receiver or the remote control, the selected component begins playing immediately. In both cases, the previously selected source continues playing without sound for a few seconds.

### Automatic Power Standby/On (only possible with the COMPU LINK-3 connection)

Both the CD player and cassette deck turn on and off with the receiver. When you turn on the receiver, the CD player or cassette deck will turn on automatically, depending which component has been previously selected. When you turn off the receiver, both the CD player and cassette deck will turn off.

### Synchronized Recording

Synchronized recording means the cassette deck starts recording as soon as a CD begins playing.

To use synchronized recording, follow these steps:

- 1 Put a tape in the cassette deck, and a disc in the CD player.
- 2 Press the record (●) button and the pause (II) button on the cassette deck at the same time.

This puts the cassette deck into recording pause.

If you do not press the record (●) button and pause (II) button at the same time, the synchronized recording feature will not operate.

- 3 Press the play (▶) button on the CD player.

The source changes on the receiver, and as soon as play starts, the cassette deck starts recording. When the play ends, the cassette deck enters recording pause, and stops about 4 seconds later.

### Notes:

- Without connecting the audio components with RCA pin plugs as described on page 9, the COMPU LINK remote control system cannot operate the components.
- Refer also to the manuals supplied with your audio components.

### Notes:

- During synchronized recording, the selected source cannot be changed.
- If your CD player is playing in program mode, a 4-second blank is recorded between tracks so that the music scan feature of your cassette deck can be used on the recorded tape.
- If the power of any component is shut off during synchronized recording, the COMPU LINK remote control system may not operate properly. In this case, you must start again from the beginning.

## Operating Other Components

You can operate JVC's audio and video components with this receiver's remote control. To operate these components with the remote control, first select a source with the source buttons on the remote control. Then, operate that source using the remote control.

### IMPORTANT:

- To operate JVC's audio components using this remote control:
  - You need to connect JVC audio components through the COMPU LINK-3 (SYNCHRO) jacks (see page 10) in addition to the connections using cables with RCA pin plugs (see page 9).
  - Aim the remote control directly at the remote sensor on the receiver.

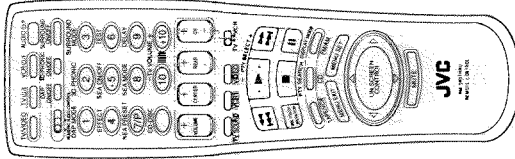

### Note:

If you choose a source on the front panel, the remote control will not operate that source.

- After pressing CD, you can perform the following operations on the CD player:

- ▶ Starts playing.
- ◀ Returns to the beginning of the current (or previous) track.
- ▶▶ Skips to the beginning of the next track.
- Stops playing.
- Pauses. To resume playing, press ▶.
- 1—10, +10 Selects a track number directly (with the NUMERIC/AUDIO CONTROL selector set to NUMERIC).



To select track number 5, press 5. For track number 15, press +10, then 5. For track number 20, press +10, then 10. For track number 30, press +10, +10, then 10.

- After pressing CD-DISC, you can perform the following operations on the CD player-changer:

- 1—6, 7P Select the number of a disc installed in a CD player-changer (with the NUMERIC/AUDIO CONTROL selector set to NUMERIC).

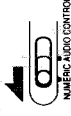

Then continue to operate the CD player as described above.

- After pressing TAPE/VCR, you can perform the following operations on the cassette deck:

- ▶ Starts play/back.
- ◀ Fast winds a tape from right to left.
- ▶▶ Fast winds a tape from left to right.
- Stops operation.
- Pauses. To resume playing, press ▶.



## Operating Other Components

### IMPORTANT:

To operate JVC's video components using this remote control:

- Aim the remote control directly at the remote sensor of the TV or VCR, not on the receiver.

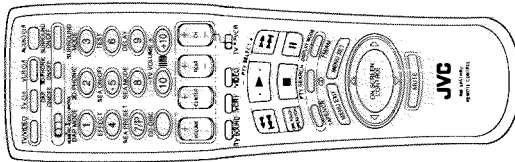

### After pressing VCR1, you can perform the following operations on the VCR:

- ▶▶ Starts playback.
- ◀◀ Rewinds a video tape.
- ▶▶ Fast winds a video tape.
- ⏸ Stops operation.
- ⏸ Pauses. To resume playing, press ▶.

You can always do the following on the VCR:

- Change the channels on the VCR using the CH +/- button when the TV/VCR selector is set to VCR.
- Turn the VCR on and off by pressing VCR .

### You can always perform the following operations on the TV:

- Change the TV's input mode to either "TV" or "VIDEO" using the TV/VIDEO button.
- Change the TV volume using the TV VOLUME +/- button when the NUMERIC/AUDIO CONTROL selector is set to AUDIO CONTROL.
- Change the channels on the TV using the CH +/- button when the TV/VCR selector is set to TV.
- Turn the TV on and off by pressing TV .

### Note:

If you choose a source on the front panel, the remote control will not operate that source.

## Troubleshooting

Use this chart to help you solve daily operational problems. If there is any problem you cannot solve, contact your JVC service center.

PROBLEM	POSSIBLE CAUSE	SOLUTION
The display does not light up.	The power cord is not plugged in or the  POWER is pressed to set it in the  OFF position.	Plug the power cord into an AC outlet and/or press  POWER to set it in the  ON position.
No sound from speakers.	Speaker signal cables are not connected.	Check speaker wiring and reconnect if necessary.
	The SPEAKERS button is not set correctly.	Press SPEAKERS to set it in the  ON position.
	An incorrect source is selected.	Select the correct source.
Sound from one speaker only.	Speaker signal cables are not connected properly.	Check speaker wiring and reconnect if necessary.
	The balance is set to one extreme.	Adjust the balance properly (see page 14).
Continuous hiss or buzzing during FM reception.	Incoming signal is too weak.	Connect an outside FM antenna or contact your dealer.
	The station is too far away.	Select a new station.
	An incorrect antenna is used.	Check with your dealer to be sure you have the correct antenna.
	Antennas are not connected properly.	Check connections.
Occasional cracking noise during FM reception.	Ignition noise from automobiles.	Move the antenna farther from automobile traffic.
No colors on the on-screen display.	The color system of the connected TV is not PAL.	Connect a PAL TV.
Menus or Visual Confirmation does not appear on the TV screen.	Incorrect video input position is selected on the TV.	Select the correct video input on your TV.
The CONTROL  /  /  button on the front panel does not work correctly, though the lamp for the corrected function selecting button is lit on the display.	The MENU SET button on the remote control is pressed. In this case the CONTROL  /  /  button works as a menu operating button.	Press the correct function selecting button again.
Remote control does not work.	There is an obstruction in front of the remote sensor on the receiver.  Batteries are weak.	Remove the obstruction.  Replace batteries.

# Specifications

## Amplifier

Output Power	At Stereo operation	70 watts per channel, min. RMS, both channels driven into 4 ohms, at 1 kHz with no more than 0.9 % total harmonic distortion. (IEC268-3/DIN)
		40 watts per channel, min. RMS, both channels driven into 8 ohms, at 1 kHz with no more than 0.9 % total harmonic distortion. (IEC268-3/DIN)
		40 watts per channel, min. RMS, both channels driven into 8 ohms, 40 Hz to 20 kHz with no more than 0.8 % total harmonic distortion.
	At Surround operation	50 watts per channel, min. RMS, driven into 8 ohms, at 1 kHz with no more than 0.8 % total harmonic distortion.
	Front channels	
	Center channel	
	Rear channels	
Total Harmonic Distortion (8 ohms, 1 kHz)		0.8 %* at 40 watts output (* Measured by JVC Audio Analysis System)
Frequency Response (8 ohms)	TV SOUND, CD, TAPE/VCR, VCR1, VIDEO	20 Hz to 20 kHz (±1 dB)
Audio Input Sensitivity/Impedance (1 kHz)	TV SOUND, CD, TAPE/VCR, VCR1, VIDEO	220 mV/47 k ohms
Audio Output Level	TAPE/VCR, VCR1	220 mV
Signal-to-Noise Ratio (66 IHF/DIN)	TV SOUND, CD, TAPE/VCR, VCR1, VIDEO	87 dB/67 dB
Loudness control (Volume Control at -40 dB)		+5 ±2 dB at 100 Hz
Video Input Sensitivity/Impedance	TAPE/VCR, VCR1, VIDEO	1 Vp-p/75 ohms
Video Output Level	TAPE/VCR, VCR1, MONITOR OUT	1 Vp-p (at 1 Vp-p input), sync negative.
Signal-to-Noise Ratio		45 dB
On-Screen Color System		PAL

## FM tuner (IHF)

Tuning Range	87.5 MHz to 108.0 MHz
Usable Sensitivity	10.8 dBf (0.95 µV/75 ohms)
50 dB Quieting Sensitivity	16.3 dBf (1.8 µV/75 ohms)
	38.3 dBf (22.5 µV/75 ohms)
Signal-to-Noise Ratio (IHF-A weighted)	80 dB at 85 dBf
	73 dB at 85 dBf
Total Harmonic Distortion	0.15 % at 1 kHz
	0.2 % at 1 kHz
Stereo Separation at REC OUT	40 dB at 1 kHz
Capture Ratio	1.5 dB (10 mV)
Alternate Channel Selectivity	60 dB (±400 kHz)
Frequency Response	30 Hz to 15 kHz; (+0.5 dB, -3 dB)

## AM (MW/LW) tuner

Tuning Range	522 kHz to 1,629 kHz (MW) 144 kHz to 288 kHz (LW)
Usable Sensitivity	300 µV/m (MW) 600 µV/m (LW)
External antenna	30 µV (MW) 100 µV (LW)
Signal-to-Noise Ratio	50 dB (100 mV/m)

## General

Power Requirements	AC 230V $\phi$ , 50 Hz
Power Consumption	240 watts 5 watts (in standby mode)
Dimensions (W x H x D)	400 x 127 x 400 mm (15 1/4 x 5 x 1 1/2 inches)
Mass	7.7 kg (17.0 lbs)

Design & specifications are subject to change without notice

# Description of Major LSIs

## ■ MN101C01DJAA1 (IC401) : System Controller

### 1. Terminal Layout

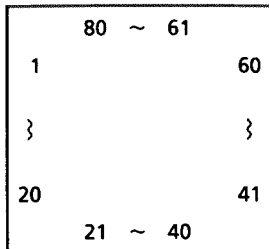

### 2. Description

Pin No.	Symbol	I/O	Function	Pin No.	Symbol	I/O	Function
1~10		--	Not used	41	VIDEO3	O	Video select signal
11	V <sub>DD</sub>	--	power supply	42	VIDEO2	O	Video select signal
12	OSC2	--	oscillation terminal	43	VIDEO1	O	Video select signal
13	OSC1	--	oscillation terminal	44	VCR S/C IN	I	VCR S/C select signal
14	V <sub>SS</sub>	--	Connect to GND	45	DATA	O	Data signal to IC201,202,252,321
15	XI	--	Connect to GND	46	CLK	O	Clock signal to IC201,202,252,321
16		--	Not used	47~51		--	Not used
17	MMDO	--	Connect to GND	52	CS	O	Chip select signal to IC411
18	DSP DATA	O	Data signal for IC081	53	REST OUT	O	Reset signal to IC411
19		--	Not used	54	DATA IN	I	Status signal for IC411
20	DSP CLK	O	Clock signal for IC081	55	DATA OUT	O	Comand signal to IC411
21	RDSRESET	O	Reset signal to IC191	56	CLK	O	Clock signal to IC411
22	RDSDATA	O	Data signal for IC191	57~59		--	Not used
23	RDSCLK	O	Clock signal for IC191	60	DAP	O	DAP ON/OFF control
24		--	Not used	61		--	Not used
25	RESET	I	System reset signal input	62	SURR.ON/OFF	O	SURROUND ON/OFF control
26	CE	O	chip enable to IC121	63~66		--	Not used
27	CLK	O	Clock signal to IC121	67	D.MUTE	O	DSP mute signal to IC041
28	DATA IN	I	Data signal for IC121	68	D.RES	O	Reset signal to IC081
29	DATA OUT	O	Data signal to IC121	69	D.CS	O	Chip select signal to IC081
30	TUNER MUTE	O	Tuner mute signal output	70	EMPTY	I	CMEM update buffer and HR resistor empty plug input
31	TUNER IN	I	Tunig signal input	71	HRS	O	Data frame synchronization signal to IC081
32	STEREO IN	I	STEREO signal input	72	STB5	O	Load strobe signal to IC061
33	D.START	I	Data start signal for IC191	73	S.MUTE	O	SORCE muteing control
34	BUSY	O	Busy signal for IC411	74		--	Not used
35	INH IN	I	Inhibit signal input	75	STB4	O	Load strobe signal to IC252
36	OSD DATA	O	On screen data to IC673	76	STB3	O	Load strobe signal to IC202
37	OSD STB	O	On screen strobe signal to IC673	77	STB2	O	Load strobe signal to IC201
38	OSD CLK	O	On screen clock signal to IC673	78	STB1	O	Load strobe signal to IC321
39	OSD ON/OFF	O	On screen ON/OFF control to IC672	79	SET.I	O	SETTING led control
40	VIDEO OFF	O	Video select signal	80	ONE.I	O	ONE TOUCH OP. led control

■ MN171602JAAN (IC411) : System controller & FL Driver

1. Terminal Layout

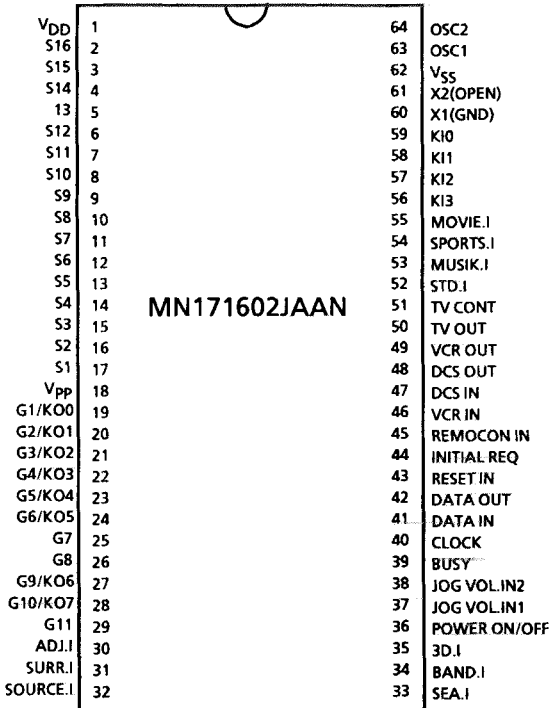

2. Key Matrix

\* MARK ONLY USED RX-5THRBK

	KEY IN 0 (PIN2)	KEY IN 1 (PIN3)	KEY IN 2 (PIN4)	KEY IN 3 (PIN5)
KEY OUT 0 (PIN6)	POWER (S401)	--	--	--
KEY OUT 1 (PIN7)	SURROUND / DAP (S402)	PRESET SEA (S403)	TUNER/BAND (S404)	SETTING (S405)
KEY OUT 2 (PIN8)	SOURCE (S406)	ADJUST (S407)	ONE TOUCH OPERATION (S408)	MEMORY (S409)
KEY OUT 3 (PIN9)	← (S410)	→ (S411)	↑ (S412)	↓ (S413)
KEY OUT 4 (PIN10)	MOVIE (S414)	SPORTS (S415)	MUSIC (S416)	3D-PHONIC (S417)
KEY OUT 5 (PIN11)	* E ON (S418)	* TA/NEWS/INFO (S419)	* PTY SELECT (S420)	* DISPLAY MODE (S421)

3. Terminal Description

Pin No.	Symbol	I/O	Function and Operations	Pin No.	Symbol	I/O	Function and Operations
1	V <sub>DD</sub>	--	Power supply	33	SEA.I	O	SEA indication control
2	S16	O	Segment control signal	34	BAND.I	O	BAND indication control
3	S15	O	Segment control signal	35	3D.I	O	3D PHONIC indication control
4	S14	O	Segment control signal	36	POWER	O	POWER ON/OFF control
5	S13	O	Segment control signal	37	IN1	I	JOG VOL. control
6	S12	O	Segment control signal	38	IN2	I	JOG VOL. control
7	S11	O	Segment control signal	39	BUSY	I	Busy signal for IC401
8	S10	O	Segment control signal	40	CLOCK	I	Clock signal for IC401
9	S9	O	Segment control signal	41	DATA IN	I	Comand signal for IC401
10	S8	O	Segment control signal	42	DATA OUT	O	Status signal to IC401
11	S7	O	Segment control signal	43	M.RES	I	Reset signal for IC401
12	S6	O	Segment control signal	44	CS	I	Chip select signal for IC401
13	S5	O	Segment control signal	45	RMI	I	Remocon signal for IC402
14	S4	O	Segment control signal	46	VCRI	I	AV COMPULINK
15	S3	O	Segment control signal	47	DCSI	I	COMPULINK signal input
16	S2	O	Segment control signal	48	DCSO	O	COMPULINK signal output
17	S1	O	Segment control signal	49	VCRO	O	AV COMPULINK
18	V <sub>pp</sub>	--	Power supply for FL display	50	TVO	O	AV COMPULINK
19	G1/KO0	O	Grid control signal (Key matrix out)	51	TVC	O	AV COMPULINK
20	G2/KO1	O	Grid control signal (Key matrix out)	52	STD.I	O	STANDBY indication control
21	G3/KO2	O	Grid control signal (Key matrix out)	53	MUSIC.I	O	MUSIC indication control
22	G4/KO3	O	Grid control signal (Key matrix out)	54	SPORTS.I	O	SPORTS indication control
23	G5/KO4	O	Grid control signal (Key matrix out)	55	MOVIE.I	O	MOVIE indication control
24	G6/KO5	O	Grid control signal (Key matrix out)	56	KI3	I	Key matrix in
25	G7	O	Grid control signal	57	KI2	I	Key matrix in
26	G8	O	Grid control signal	58	KI1	I	Key matrix in
27	G9/KO6	O	Grid control signal (Key matrix out)	59	KI0	I	Key matrix in
28	G10/KO7	O	Grid control signal (Key matrix out)	60	X1	--	Connected to GND
29	G11	O	Grid control signal	61	X2	--	Not used
30	ADJ.I	O	ADJUST indication control	62	VSS	--	GND
31	SURR.I	O	SURROUND indication control	63	OSC1	--	Oscillation terminal
32	SOURCE.I	O	SOURCE indication control	64	OSC2	--	Oscillation terminal

■ LC72131 (IC102) : PLL Synthesizer

1. Terminal Layout

XIN	1	22	XOUT
	2	21	VSS
PLLCE	3	20	LPF OUT
PLLDA	4	19	LPF IN
PLLCK	5	18	PD
IFDATA	6	17	VDD
$\overline{\text{FM}}$	7	16	FM OSC
$\overline{\text{MW}}$	8	15	AM OSC
$\overline{\text{LW}}$	9	14	
AUTO/MONO	10	13	IF REQ
POWER	11	12	FM/AM IF

2. Block Diagram

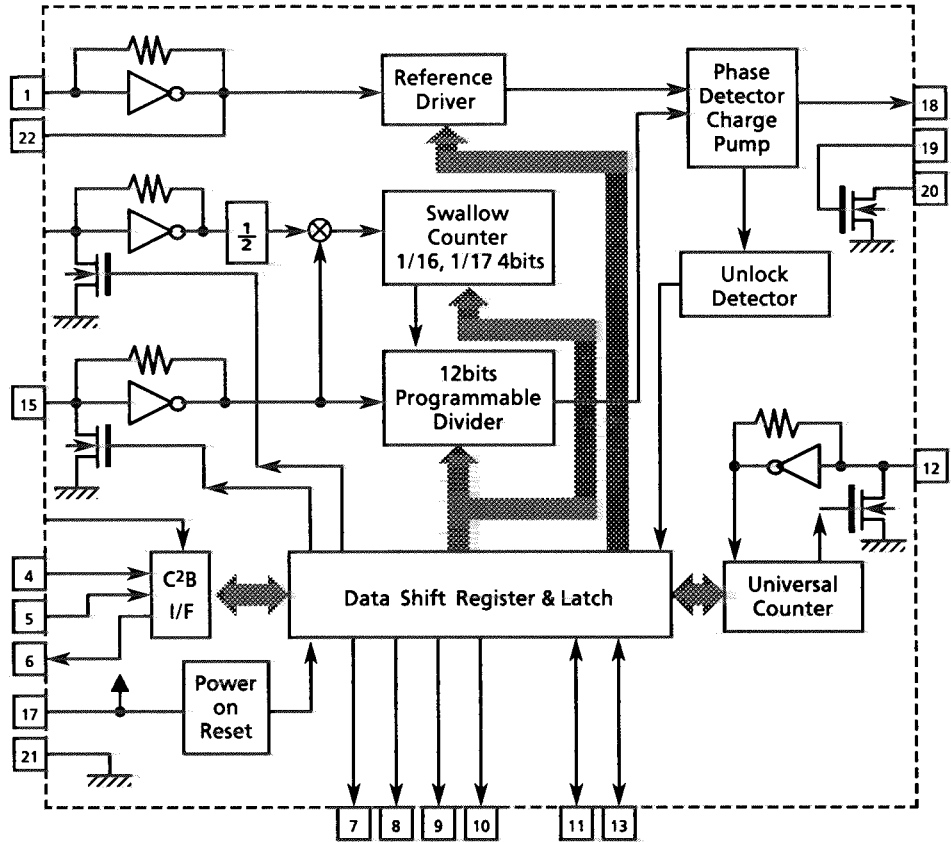

3. Pin Functions

Pin No.	Symbol	I/O	Functions	Pin No.	Symbol	I/O	Functions
1	X in	I	Crystal oscillator (7.2MHz).	12	FM/AM IF	I	Universal counter input
2		--	Not use	13	IF REQ	O	Output the "IF-signal request" to IC102
3	PLLCE	I	Fix the chip enable to "H" when inputting(DI) and outputting (DO) the serial data	14		I	Not use
4	PLLDA	I	Receive the control data from the controller (IC201).	15	AMOSC		Input the local oscillator signal of AM.
5	PLLCK	I	This clock is used to synchronize data when transmitting the data of DI and DO.	16	FM OSC	I	Input the local oscillator signal of FM.
6	IFDATA	O	Transmit the data from LC72131 to the controller which is synchronized with CK.	17	VDD	O	This is a terminal of power supply.
7	$\overline{\text{FM}}$	O	It is "L" on FM mode.	18	PD	O	PLL charge pump output : When the local oscillator signal frequency is higher than the reference frequency high level signals will output. When it is lower than the reference frequency, low level signals will output. When it is same as reference frequency signals, it will be floating.
8	$\overline{\text{MW}}$	O	It is "L" on MW mode.	19	LPF IN	I	Transistor used for the PLL active low-pass filter
9	$\overline{\text{LW}}$	O	It is "L" on LW mode.	20	LPF OUT	O	Transistor used for the PLL active low-pass filter
10	AUTO/MONO	O	It is "L" on monaural, "H" on auto.	21	VSS	--	Connected to GND
11	POWER	O	Regulator control signal PON "H", STANDBY "L"	22	X out	O	Crystal oscillator (7.2MHz).

■ LA1837 (IC102) : FM AM IF AMP & detector, FM MPX Decoder

1. Block Diagram

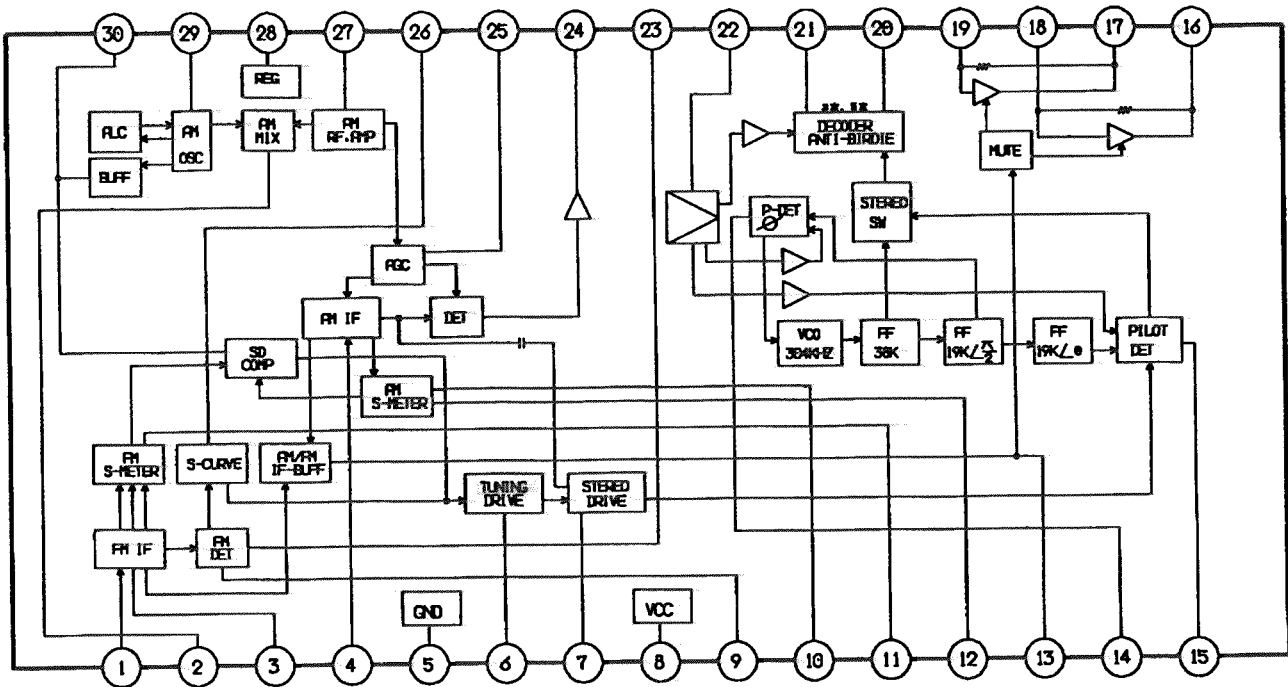

3. Pin Function

Pin No.	Symbol	I/O	Function	Pin No.	Symbol	I/O	Function
1	FM IN	I	This is an input terminal of FM IF Signal.	16	L OUT	O	Left channel signal output.
2	AM MIX	O	This is an output terminal for AM mixer.	17	R OUT	O	Right channel signal output
3	FM IF	I	Bypass of FM IF	18	L IN	I	Input terminal of the Left channel post AMP.
4	AM IF	I	Input of AM IF Signal.	19	R IN	I	Input terminal of the Right channel post AMP.
5	GND	—	This is the device ground terminal.	20	RO	O	Mpx Right channel signal output.
6	TUNED	O	When the set is tuning, this terminal becomes "L".	21	LO	O	Mpx Left channel signal output.
7	STEREO	O	Stereo indicator output. Stereo : "L", Mono : "H"	22	IF IN	I	Mpx input terminal.
8	VCC	—	This is the power supply terminal.	23	FM OUT	O	FM detection output.
9	FM DET	—	FM detect transformer.	24	AM DET	O	AM detection output.
10	AM SD	—	This is a terminal of AM ceramic filter.	25	AM AGC	I	This is an AGC voltage input terminal for AM.
11	FM VSM	O	Adjust FM SD sensitivity.	26	AFC	—	This is an output terminal of voltage for FM-AFC.
12	AM VSM	O	Adjust AM SD sensitivity.	27	AM RF	I	AM RF signal input.
13	MUTE	I/O	When the signal of IF REQ of IC121( LC72131 ) appear, the signal of FM/AM IF output. //Muting control input.	28	REG	O	Register value between pin26 and pin28 desides the frequency width of the input signal.
14	FM/AM	I	Change over the FM / AM input. "H" : FM, "L" : AM	29	AM OSC	—	This is a terminal of AM Local oscillation circuit.
15	MONO/ST	O	Stereo : "H", Mono : "L"	30	OSC BUFFER	O	AM Local oscillation Signal output.

■ LC7073M (IC191) : Radio Data System (Only used RX-5THRBK)

1. Terminal Layout

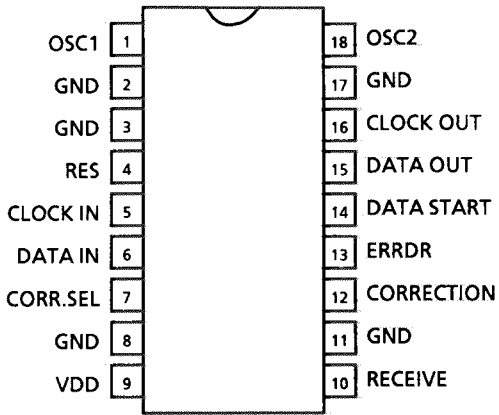

2. Block Diagram

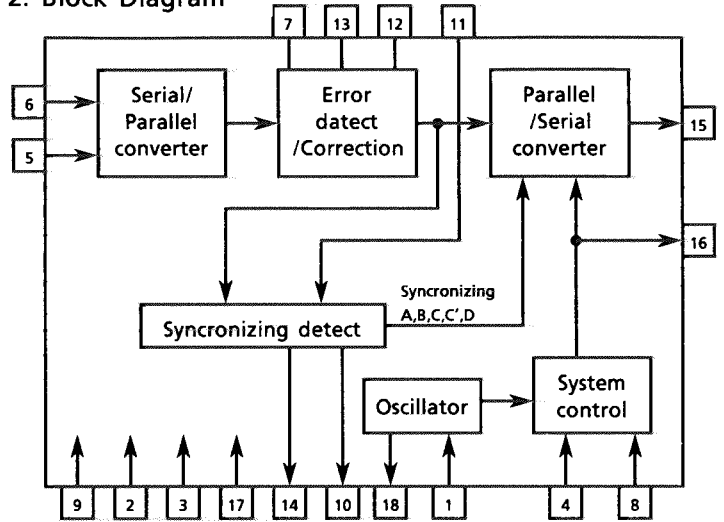

3. Pin Functions

Pin No.	Symbol	I/O	Function	Pin No.	Symbol	I/O	Function
1	OSC1	I	Oscillation terminal	10	RECEIVE	—	Non connection
2	GND	—	GND	11	GND	—	GND
3	GND	—	GND	12	CORRECTION	—	Non connection
4	RES	I	Reset input	13	ERRDR	—	Non connection
5	CLOCK IN	I	RDS clock input	14	DATA START	O	Data start signal for block data to output serial data
6	DATA IN	I	RDS data input	15	DATA OUT	O	Serial data output
7	CORR.SEL	I	Non connection	16	CLOCK OUT	O	Data output of serial data output
8	GND	—	GND	17	GND	—	GND
9	VDD	—	Power supply	18	OSC2	O	Oscillation terminal

■ SAA6579T (IC192) : Radio data system demodulator (Only used RX-5THRBK)

1. Terminal Layout

QUAL	1	16	CL
DA	2	15	T57
Vref	3	14	X2
MUX	4	13	X1
V <sub>DD</sub>	5	12	V <sub>DD</sub>
GND	6	11	GND
CIN	7	10	GND
OUT	8	9	GND

2. Pin Function

Pin No.	Symbol	I/O	Function
1	QUAL	—	Non connection
2	DA	O	RDS data output
3	Vref	O	Reference voltage output
4	MUX	I	Multiplex signal input
5	V <sub>DD</sub>	—	+5V supply voltage for analog part
6	GND	—	Ground for analog part (0V)
7	CIN	I	Subcarrier input to comparator
8	OUT	O	Subcarrier output of reconstruction filter
9	GND	—	Ground for digital part (0V)
10	GND	—	Ground for digital part (0V)
11	GND	—	Ground for digital part (0V)
12	V <sub>DD</sub>	—	+5V supply voltage for digital part
13	X1	I	Oscillator input
14	X2	O	Oscillator output
15	T57	—	Non connection
16	CL	O	RDS clock output

3. Block Diagram

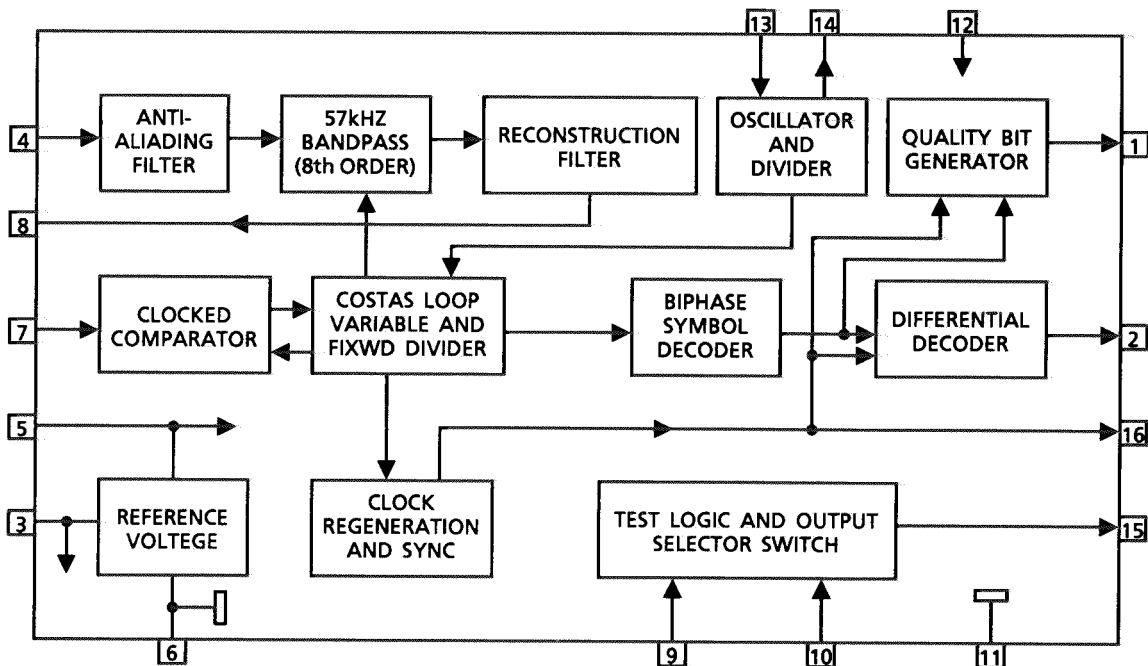



■ GP1U501X (IC402) : Receiver for remote controller

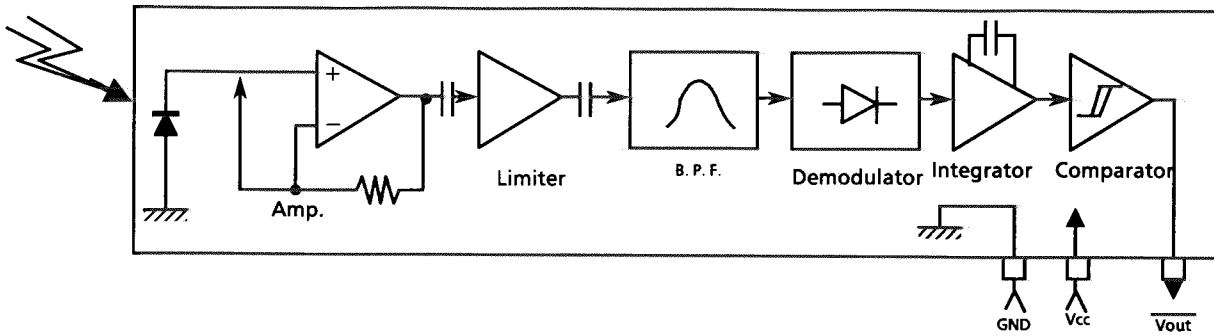

■ PST600E (IC403) : Reset IC

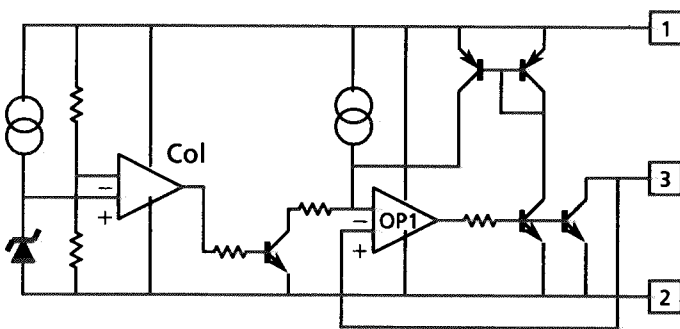

■ TA7317P (IC901) : PROTECTOR IC

(1) Terminal Layout

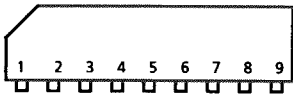

(2) Block Diagram

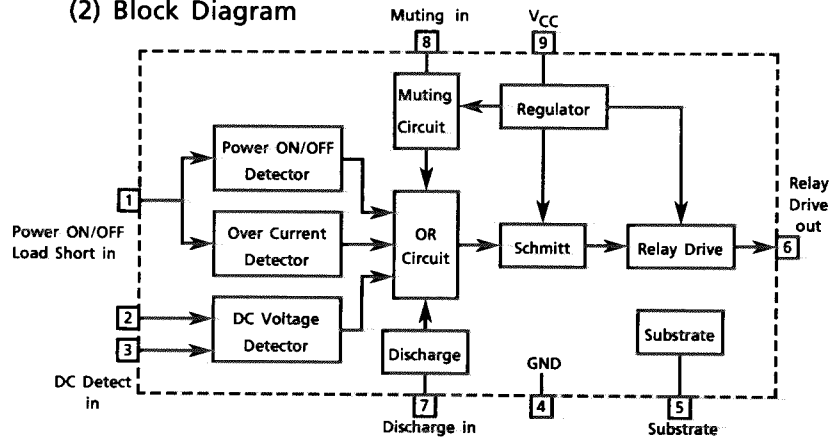

■ PCM1717E (IC041,061) : D/A Converter

1. Terminal Layout

XTI	1	20	XTO
DGND	2	19	CLKO
VDD	3	18	ML/MUTE
LRCIN	4	17	MC/DM1
DIN	5	16	MD/DM0
BCKIN	6	15	RSTB
ZERO	7	14	MODE
D/CR	8	13	D/CL
VOU <sub>TR</sub>	9	12	VOU <sub>TL</sub>
AGND	10	11	VCC

2. Block Diagram

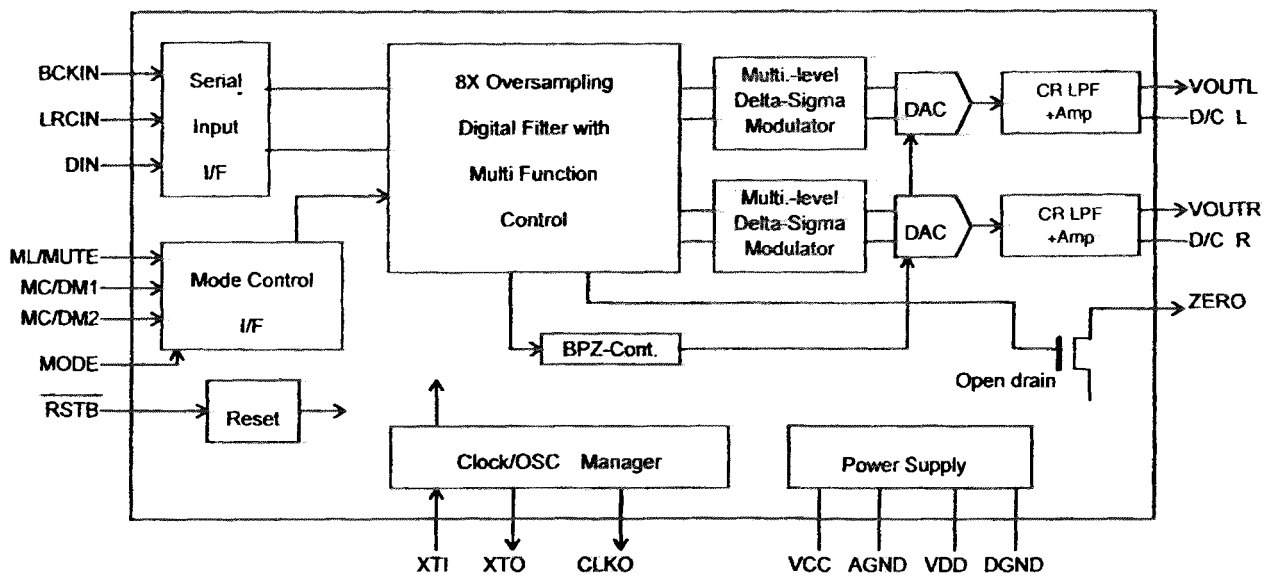

3. Description

Pin No	Symbol	I/O	Function	Pin No	Symbol	I/O	Function
1	XTI	I	Crystal oscillator input	11	VCC	--	Analog power supply
2	DGND	--	Digital ground	12	VOU <sub>TL</sub>	O	Lch analog voltage output
3	VDD	--	Digital power supply	13	D/CL	--	Lch analog output amp common terminal
4	LRCIN	I	Reference sampling input	14	MODE	I	interface mode select terminal
5	DIN	I	PCM audio data input	15	RSTB	--	Not used
6	BCKIN	I	Bit clock for PCM audio data input	16	MD/DM0	I	Various control data / De-emphasis control
7	ZERO	--	Not used	17	MC/DM1	I	Bit clock for various control data / De-emphasis
8	D/CR	--	Rch analog output amp common terminal	18	ML/MUTE	I	Load strobe for various control data / Mute control
9	VOU <sub>TR</sub>	O	Rch analog voltage output	19	CLKO	O	inverting input of XT1
10	AGND	--	Analog ground	20	XTO	O	Crystal oscillator output

■ LC32464M-80(IC091) : 256K bit Dynamic RAM

1. Terminal Layout

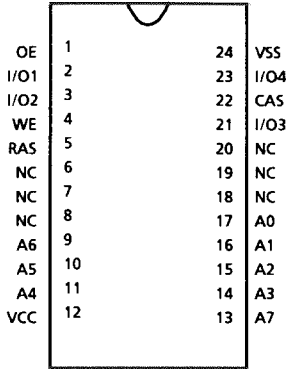

2. Description

Pin No.	Symbol	I/O	Function
1	OE	I	Output enable
2,3	I/O1,2	I/O	Data input/output
4	WE	I	Write enable
5	RAS	I	Row address strobe
6~8	NC	--	Non connection
9~11	A6~A4	I	Address input
12	V <sub>CC</sub>	--	Power supply
13~17	A7,A3~A0	I	Address input
18~20	NC	--	Non connection
21	I/O3	I/O	Data input/output
22	CAS	I	Column address strobe
23	I/O4	I/O	Data input/output
24	V <sub>SS</sub>	--	GND

3. Block Diagram

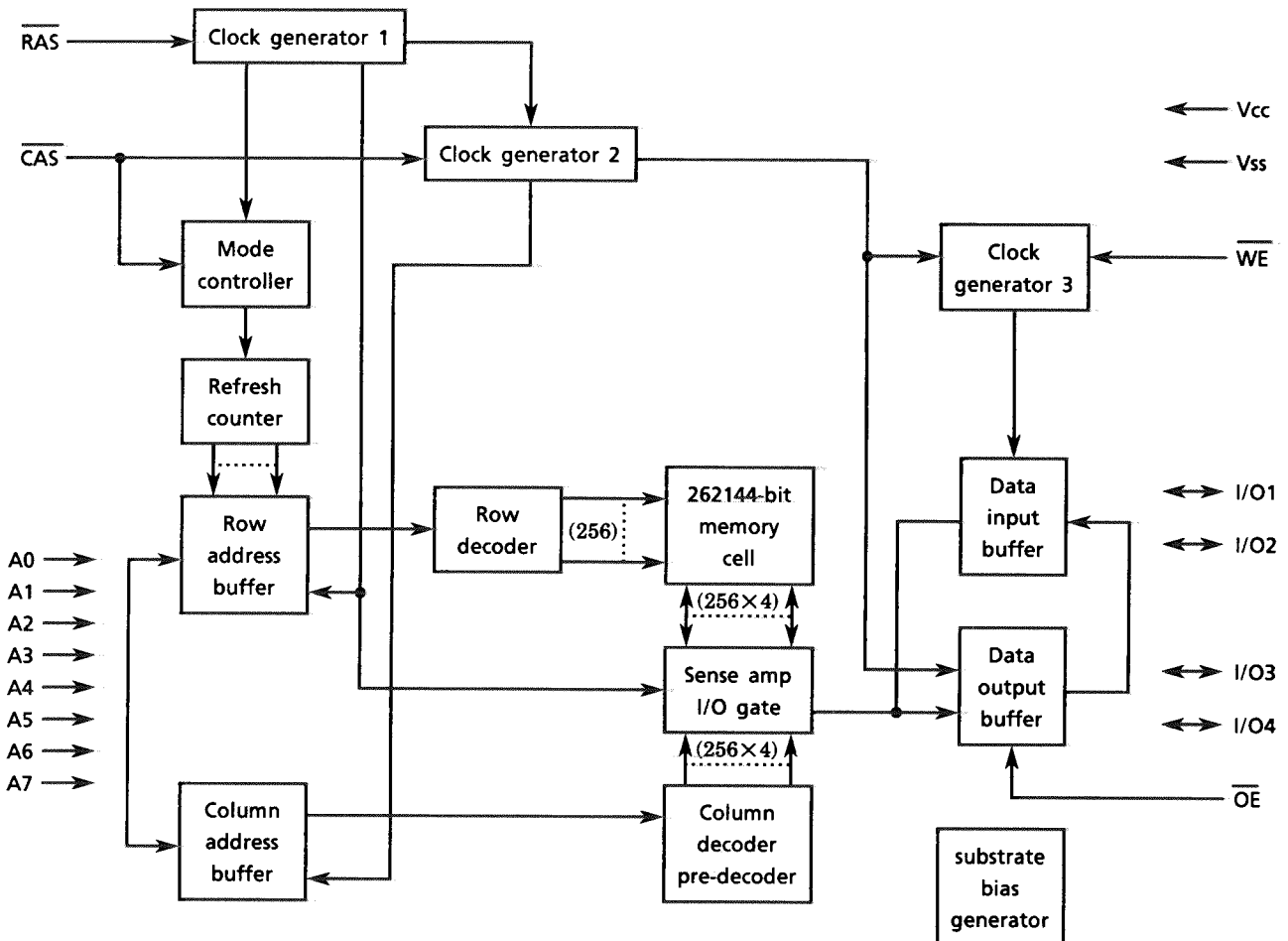

■ SAA7367T (IC021) : A/D Converter

1. Terminal Layout

SFOR	1	24	SLAVE
STDB	2	23	VDDA
OVLD	3	22	VREFL
CKIN	4	21	BIL
VDD	5	20	BOL
VSS	6	19	VDACP
SDO	7	18	VDACN
SWS	8	17	BOR
SCK	9	16	BIR
TEST 1	10	15	VREFR
HPEN	11	14	IREF
TEST B	12	13	VSSA

2. Block Diagram

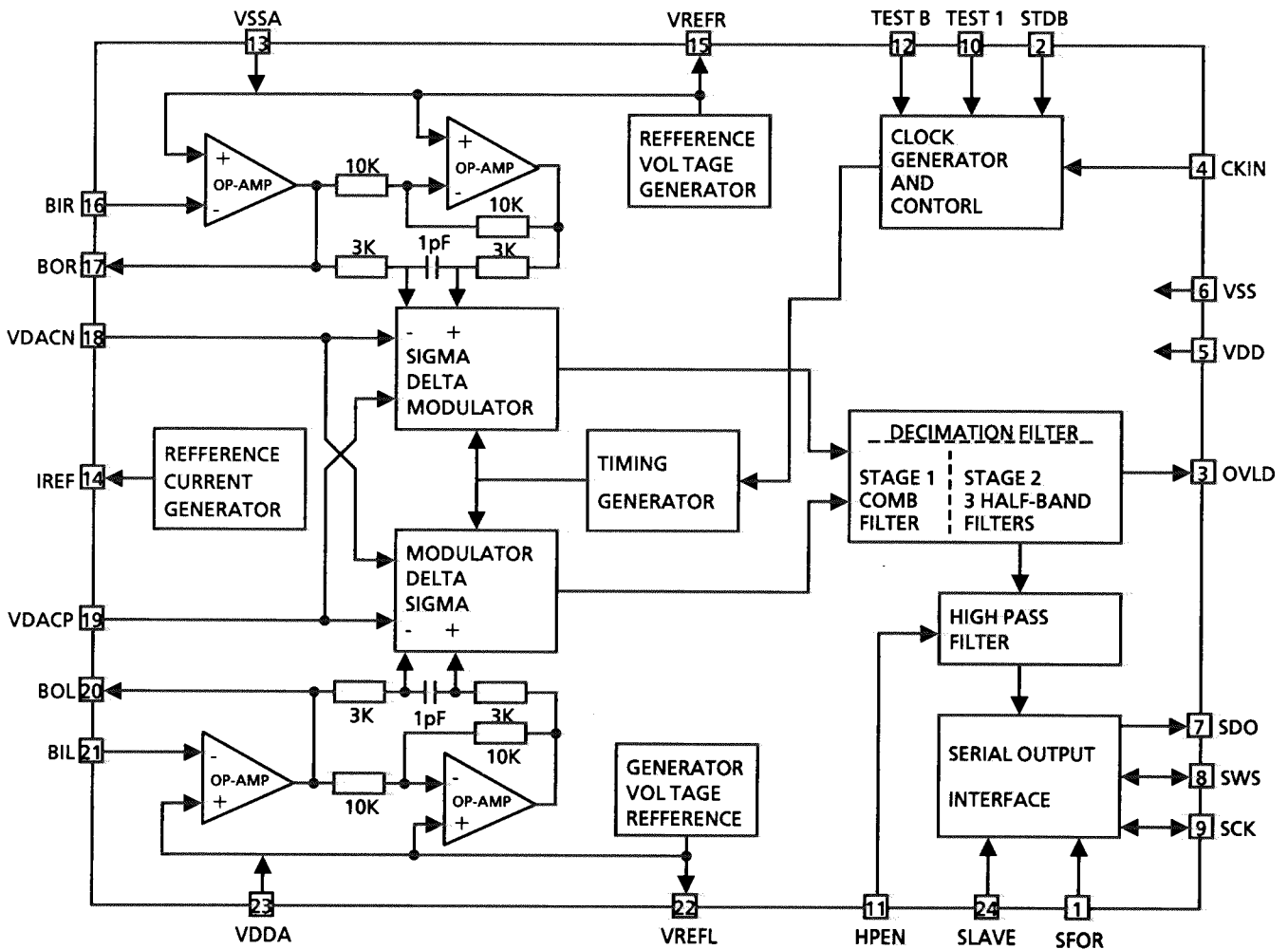

## 3. Description

Pin No.	Symbol	I/O	Functions
1	SFOR	I	Input for selecting serial interface output format. HIGH = Format 1 LOW = Format 2
2	STDB	I	Input for selecting STANDBY mode HIGH = Normal operation LOW = STANDBY (Low power consumption)
3	OVL	O	Overload indication output. This pin indicates whether the internal digital signal is within 1dB of maximum. In STANDBY mode this output is in high impedance
4	CKIN	I	System clock input from IC093
5	VDD	--	Supply for the digital section (5V)
6	VSS	--	Ground supply for the digital section
7	SDO	O	Serial interface data output to IC081. In STANDBY mode this output is in high impedance
8	SWS	I/O	Serial interface word select signal. This pin is the word select input to the serial interface.
9	SCK	I/O	Serial interface clock. This pin is the input for the external bit clock.
10	TEST1	I	Test input 1. This pin should be left open circuit
11	HPEN	I	High pass filter enable input. (HPEN HIGH = enabled). If unconnected this pin defaults HIGH
12	TESETB	I	Test input 2. This pin should be left open circuit
13	VSSA	--	Ground supply for the analogue section
14	IREF	--	Current reference mode
15	VREFR	--	VDDA/2 reference generator for the right channel analog section
16	BIR	I	Buffer op-amp inverting input for right channel
17	BOR	O	Buffer op-amp output for right channel
18	VDACN	I	Negative 1 bit DAC reference voltage input, normally connected to 0V
19	VDACP	I	Positive 1 bit DAC reference voltage input, normally connected to 5V
20	BOL	O	Buffer op-amp output for left channel
21	BIL	I	Buffer op-amp inverting input for left channel
22	VREFL	--	VDDA/2 reference generator for the left channel analog section
23	VDDA	--	Supply for the analog section (5V)
24	SLAVE	I	Input for selecting serial interface operating mode MASTER/SLAVE HIGH = SLAVE, LOW = MASTER If unconnected the pin will default LOW

■ TMS57052 (IC081) : DSP LSI

1. Terminal Layout

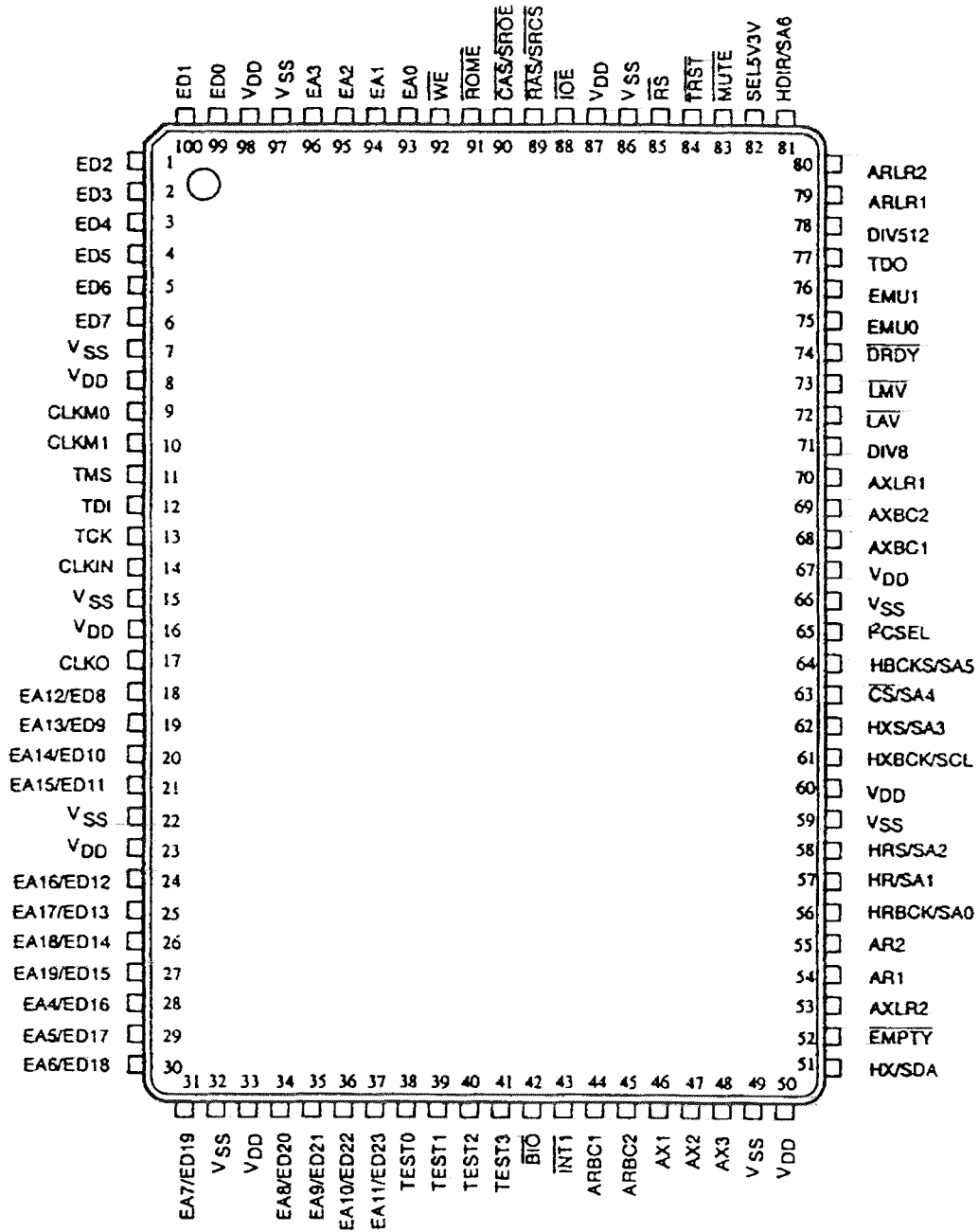

## 2. Description

Pin No.	Symbol	I/O	Function	Pin No.	Symbol	I/O	Function
1	ED2	I/O	External memory and I/O data bus	26	EA18/ED14	I/O	External SRAM and ROM address bus / External DRAM and I/O data bus
2	ED3	I/O	External memory and I/O data bus	27	EA19/ED15	I/O	External SRAM and ROM address bus / External DRAM and I/O data bus
3	ED4	I/O	External memory and I/O data bus	28	EA4/ED16	I/O	External memory address bus / External I/O data bus
4	ED5	I/O	External memory and I/O data bus	29	EA5/ED17	I/O	External memory address bus / External I/O data bus
5	ED6	I/O	External memory and I/O data bus	30	EA6/ED18	I/O	External memory address bus / External I/O data bus
6	ED7	I/O	External memory and I/O data bus	31	EA7/ED19	I/O	External memory address bus / External I/O data bus
7	V <sub>SS</sub>	--	GND	32	V <sub>SS</sub>	--	GND
8	V <sub>DD</sub>	--	Power supply	33	V <sub>DD</sub>	--	Power supply
9	CLKM0	I	Clock mode	37	EA11/ED23	I/O	External memory address bus / External I/O data bus
10	CLKM1	I	Clock mode	38	TEST0	I	Test mode control
11	TMS	I	Test access port mode select	39	TEST1	I	Test mode control
12	TDI	I	Test access port data input	34	EA8/ED20	I/O	External memory address bus / External I/O data bus
13	TCK	I	Test access port clock	35	EA9/ED21	I/O	External memory address bus / External I/O data bus
14	CLKIN	I	Master clock input	36	EA10/ED22	I/O	External memory address bus / External I/O data bus
15	V <sub>SS</sub>	--	GND	40	TEST2	I	Test mode control
16	V <sub>DD</sub>	--	Power supply	41	TEST3	I	Test mode control
17	CLKO	O	Machine clock	42	$\overline{\text{BIO}}$	I	Divergence control input
18	EA12/ED8	I/O	External SRAM and ROM address bus / External DRAM and I/O data bus	43	$\overline{\text{INT1}}$	I	Interrupt 1
19	EA13/ED9	I/O	External SRAM and ROM address bus / External DRAM and I/O data bus	44	ARBC1	I	Audio data receive unit 1 bit clock
20	EA14/ED10	I/O	External SRAM and ROM address bus / External DRAM and I/O data bus	45	ARBC2	I	Audio data receive unit 2 bit clock
21	EA15/ED11	I/O	External SRAM and ROM address bus / External DRAM and I/O data bus	46	AX1	O	Audio data transmission unit 1 data output
22	V <sub>SS</sub>	--	GND	47	AX2	O	Audio data transmission unit 2 data output
23	V <sub>DD</sub>	--	Power supply	48	AX3	O	Audio data transmission unit 3 data output
24	EA16/ED12	I/O	External SRAM and ROM address bus / External DRAM and I/O data bus	49	V <sub>SS</sub>	--	GND
25	EA17/ED13	I/O	External SRAM and ROM address bus / External DRAM and I/O data bus	50	V <sub>DD</sub>	--	Power supply

Pin No.	Symbol	I/O	Function	Pin No.	Symbol	I/O	Function
51	HX/SDA	I/O	Host interface data output / I <sup>2</sup> C bass data	76	EMU1	I/O	Emulator interrupt 1
52	$\overline{\text{EMPTY}}$	O	CCMEM update buffer and HR resistor empty fiug output	77	TDO	O	Test access port data output
53	AXLR2	I	Audio data transmission unit 2 L/R channel frame synchronization signal	78	DIV512	O	1/512 machine clock output
54	AR1	I	Audio data receive unit 1 data input	79	ARLR1	I	Audio data receive unit 1 L/R channel frame synchronization signal
55	AR2	I	Audio data receive unit 2 data input	80	ARLR2	I	Audio data receive unit 2 L/R channel frame synchronization signal
56	HRBCK/SA0	I	Host interface receive clock / I <sup>2</sup> C bass address 0	81	HDIR/SA6	I	Host interface data format select / I <sup>2</sup> C bass address 6
57	HR/SA1	I	Host interface data input / I <sup>2</sup> C bass address 1	82	SELSV3V	I	Input level control
58	HRS/SA2	I	Host interface receive data frame synchronization signal / I <sup>2</sup> C bass address 2	83	$\overline{\text{MUTE}}$	I	Mute control
59	V <sub>SS</sub>	--	GND	84	$\overline{\text{TRST}}$	I	Test access port reset
60	V <sub>DD</sub>	--	Power supply	85	$\overline{\text{RS}}$	I	Hord wear reset
61	HXBCK/SCL	I	Host interface transmission clock / I <sup>2</sup> C bass clock	86	V <sub>SS</sub>	--	GND
62	HXS/SA3	I	Host interface transmissiondata frame synchronization signal / I <sup>2</sup> C bass address 3	87	V <sub>DD</sub>	--	Power supply
63	$\overline{\text{CS}}/SA4$	I	Host interface chip select / I <sup>2</sup> C bass address 4	88	$\overline{\text{IOE}}$	O	External I/O enable
64	HBCKS/SA5	I	HRBCK/HXBCK ACTIVE EDGE SELECT / I <sup>2</sup> C bass address 5	89	$\overline{\text{RAS}}/\text{SRCS}$	O	External DRAM row address strobe /External SRAM chip select
65	I <sup>2</sup> CSEL	I	Host interface MODE	90	$\overline{\text{CAS}}/\text{SROE}$	O	External DRAM column address strobe /External SRAM output enable
66	V <sub>SS</sub>	--	GND	91	$\overline{\text{ROME}}$	O	External ROM enable
67	V <sub>DD</sub>	--	Power supply	92	$\overline{\text{WE}}$	O	External memory and I/O write enable
68	AXBC1	I	Audio data transmission unit 1 bit clock	93	EA0	O	External memory and I/O address bus
69	AXBC2	I	Audio data transmission unit 2 bit clock	94	EA1	O	External memory and I/O address bus
70	AXLR1	I	Audio data transmission unit 1 L/R channel frame synchronization signal	95	EA2	O	External memory and I/O address bus
71	DIV8	O	1/8 machine clock output	96	EA3	O	External memory and I/O address bus
72	$\overline{\text{LAV}}$	O	Latch ALU overflow fiug output	97	V <sub>SS</sub>	--	GND
73	$\overline{\text{LMV}}$	O	Latch MAC overflow fiug output	98	V <sub>DD</sub>	--	Power supply
74	$\overline{\text{DRDY}}$	O	Host interface transmissiondata data ready fiug output	99	ED0	I/O	External memory and I/O data bus
75	EMU0	I/O	Emulator interrupt 0	100	ED1	I/O	External memory and I/O data bus



■ NJM2246D (IC671) : Video Switch

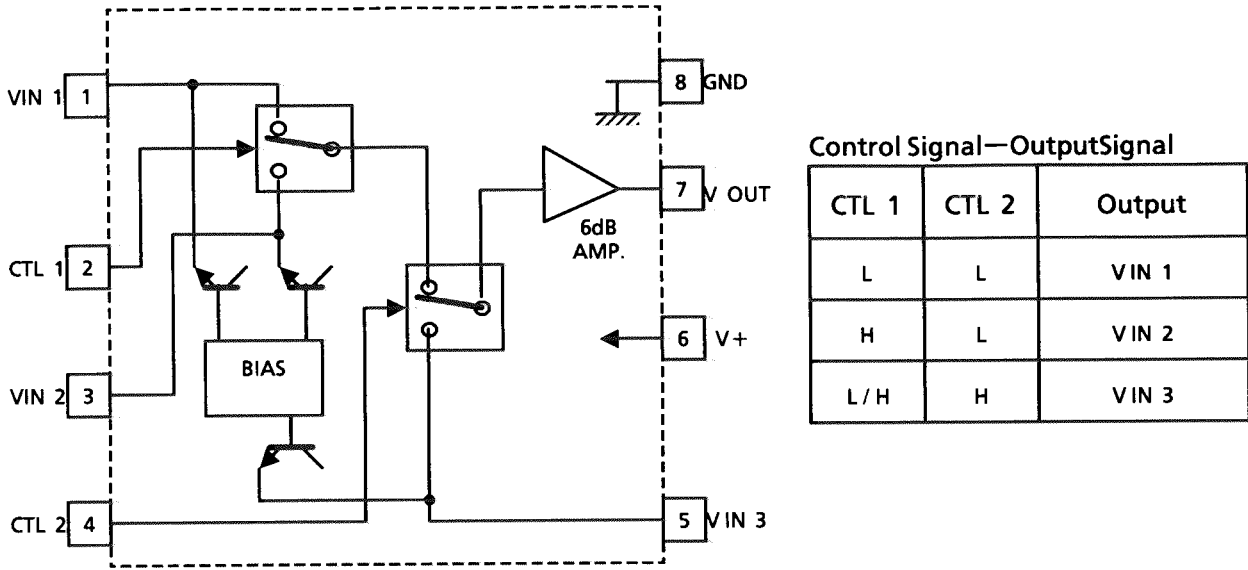

■ M5243P (IC551) : S.E.A. Graphic Equalizer

1. Functions  
It makes inductive characteristic instead of coil.
2. Block Diagram

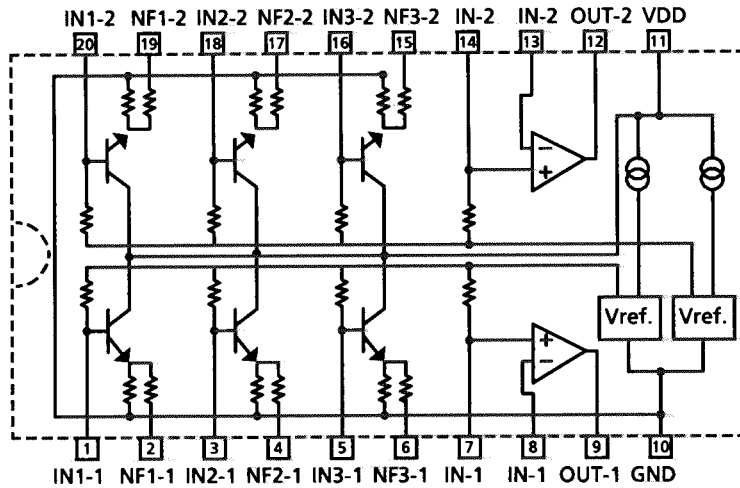

■ IC673 : M35012-120SP (ON SCREEN IC)

(1) Terminal Layout

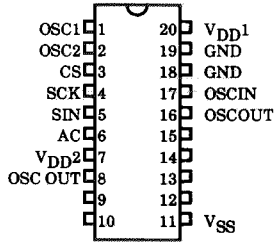

(2) Block Diagram

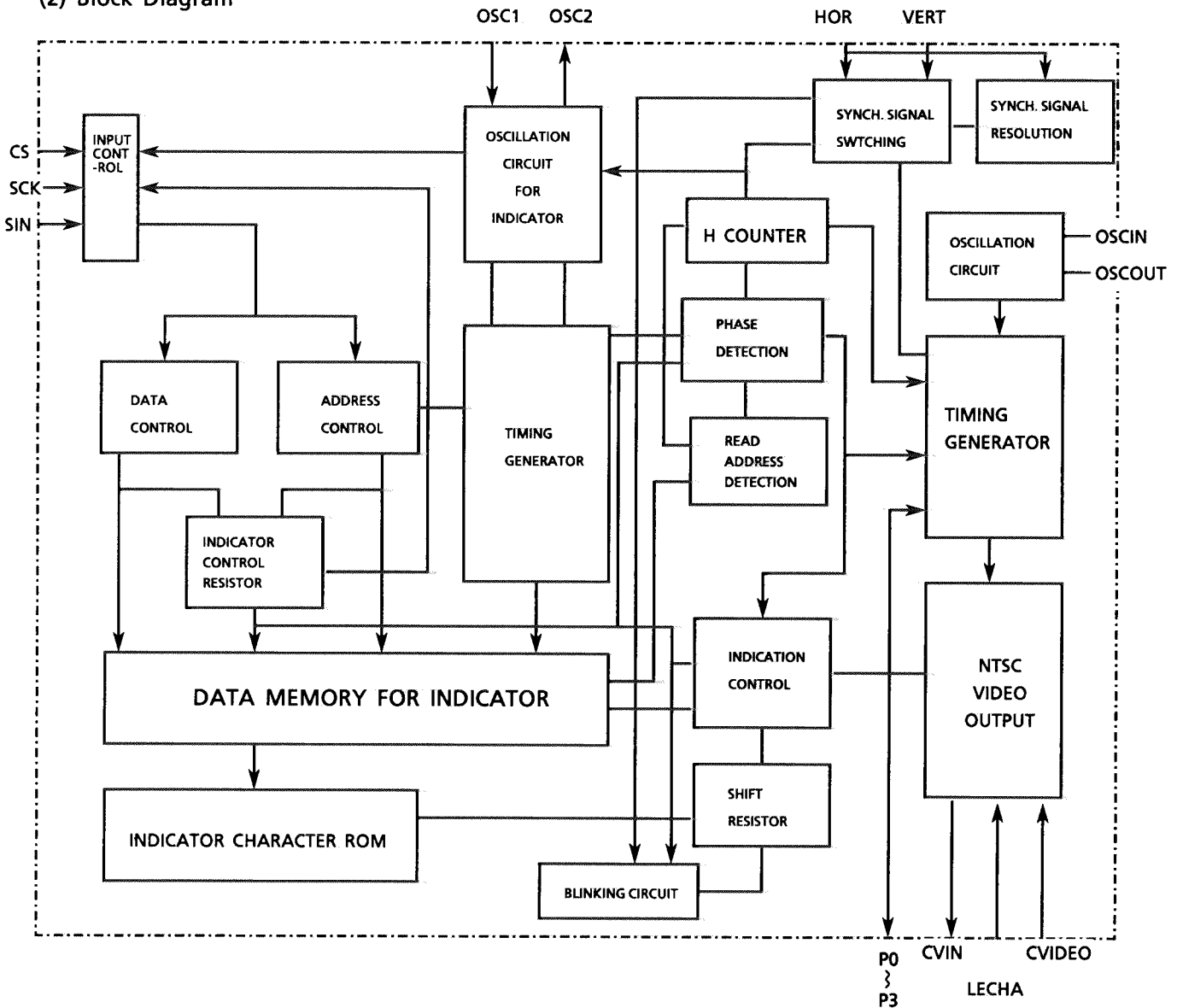

## (3) Pin Functions

Pin No.	Pin Name	Functions
1	OSC1	Oscillation terminal
2	OSC2	Oscillation terminal
3	CS	Chip Select
4	SCK	Serial clock signal
5	SIN	Serial data input
6	AC	Auto clear input
7	VDD2	Power supply
8	OSC OUT	Composite video signal input
9		NC
10		NC
11	VSS	GND
12		NC
13		NC
14		NC
15		NC
16	OSCOU	Oscillation terminal
17	OSCIN	Oscillation terminal
18	GND	
19	GND	
20	VDD1	Power supply

■ TC9163AN(IC252) , TC9164AN(IC321) : Analog Switch

1. Functions

These analog switches are controlled by 14 bit serial data from computer for selecting the source.

2. Terminal Layout & Block diagram

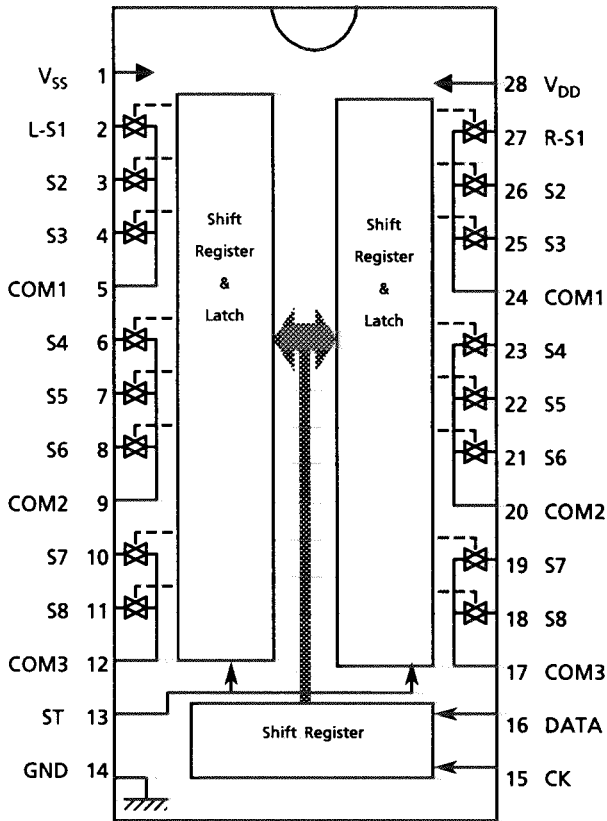

TC9163AN

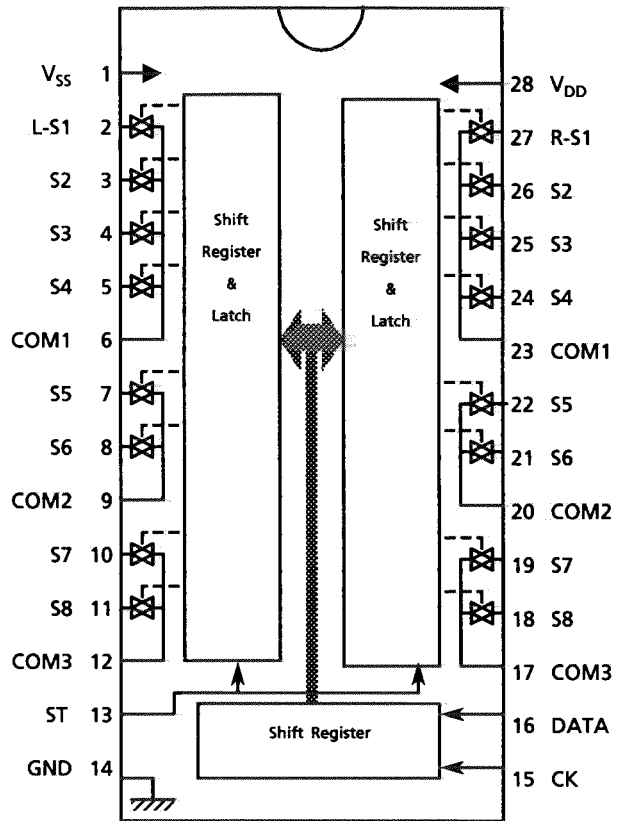

TC9164AN

3. First 10bits are used to source select. Last 4bits are chip select. The switches (S1~S8) are connected to common terminals (COM1~COM3) according to the DATA from computer.

	Chip Select Bit			
	S11	S12	S13	S14
TC9163AN	1	0	0	0
TC9164AN	0	1	0	0

# Internal Connections for FL Display Tube

GRID ASSIGNMENT

1G

10G

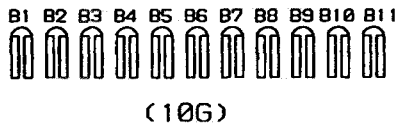
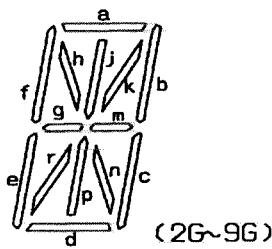
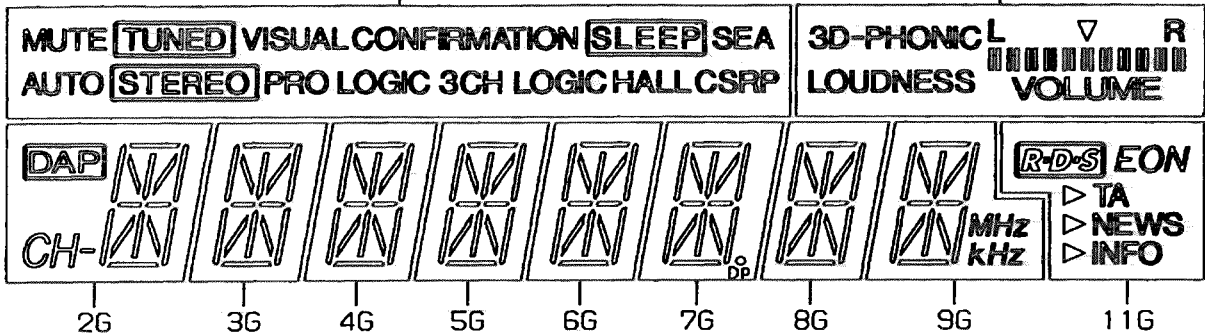

ANODE CONNECTION

	1G	2G	3G-6G	7G	8G	9G	10G	11G
P1	MUTE AUTO	a	a	a	a	a	B1	RDS
P2	TUNED	b	b	b	b	b	B2	EON
P3	STEREO	j	j	J	J	j	B3	>TA
P4	VISUAL CONFIRMATION	k	k	k	k	k	B4	>NEWS
P5	SLEEP	h	h	h	h	h	B5	>INFO
P6	CSRP	f	f	f	f	f	B6	-
P7	-	m	m	m	m	m	B7	-
P8	-	g	g	g	g	g	B8	-
P9	HALL	c	c	c	c	c	B9	-
P10	3CH LOGIC	n	n	n	n	n	B10	-
P11	-	r	r	r	r	r	B11	-
P12	-	p	p	p	p	p	LOUDNESS	-
P13	PRO LOGIC	e	e	e	e	e	VOLUME	-
P14	-	d	d	d	d	d	L R	-
P15	SEA	CH-	-	DP	-	MHz	3D-PHONIC	-
P16	-	DAP	-	-	-	kHz	∇	-

PIN CONNECTION

PIN NO.	3	3	3	3	3	3	3	3	3	2	2	2	2	2	2	2	2	2	1	1	1	1	1	1	1	1	1	1	1	9	8	7	6	5	4	3	2	1	
CONNECTION	F	F	N	N	I	I	0	9	8	7	6	5	4	3	2	1	N	N	N	N	P	P	P	P	P	P	P	P	P	P	P	P	P	P	P	N	N	F	F

- NOTE 1) F1, F2 --- Filament  
 2) NP ----- No Pin  
 3) NC ----- No connection  
 4) DL ----- Datum Line  
 5) 1G~11G --- Grid

## Disassembly Procedures

### ■ Top cover removal

1. Remove 4 screws (A) on both sides of the top cover and 3 screws (B) on the rear side.(FIG.1)
2. Lift the back of the top cover spreading both sides to remove.

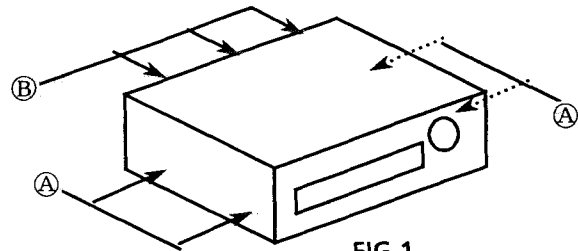

FIG.1

### ■ Front panel assembly removal

1. Remove the top cover.
2. Remove 3 screws (K) on the bottom side and 3 screws (C) on the top side.(FIG.2,4)
3. Disconnect the wires CN305,CN602,CN603 and CN801. Disconnect the wire CN112.
4. Cut the tie bands on the tuner p.c.board and ENC-135-6.
5. Remove 2 hooks on both sides of the front panel assembly.
6. Remove the front panel assembly.

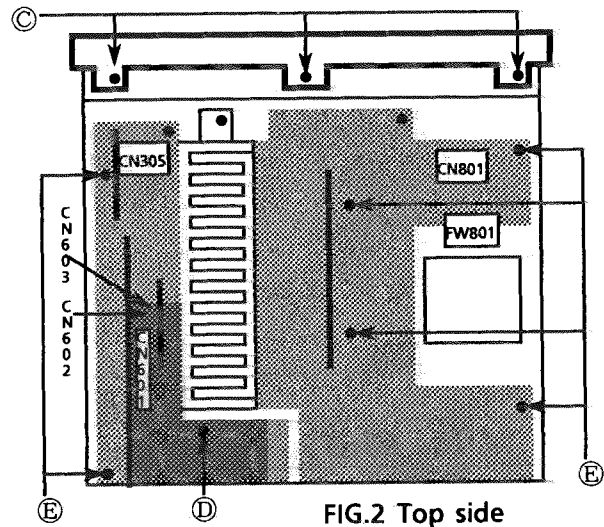

FIG.2 Top side

### ■ Rear panel removal

1. Remove the top cover.
2. Remove 20 screws (F),(G),(H) and (I). (FIG.3)
3. Remove the power cord stopper up side.
4. Remove the rear panel.

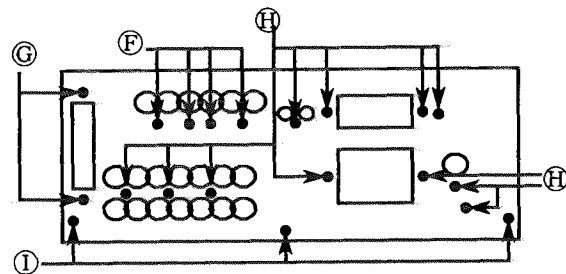

FIG.3 Rear side

### ■ Video P.C.Board removal

1. Remove the top cover.
2. Remove 5 screws (D) and (F).(FIG.2,3)
3. Disconnect the wires CN602 and CN603.
4. Disconnect the connector CN601.
5. Remove the video P.C.Board(ENC-135-2).

### ■ Tuner P.C.Board removal

1. Remove the top cover.
2. Remove 2 screws (C).(FIG.3)
3. Disconnect the connector CN101. Disconnect the wire CN112.
4. Remove the tuner P.C.Board(ENA-178).

### ■ Main amp. P.C.Board with same P.C.Board and front bracket removal

1. Remove the top cover.
2. Remove the front panel assembly.
3. Cut the tie band FW801.
4. Remove 6 screws (E).(FIG.2)
5. Remove 3 screws (I).(FIG.3)
6. Remove 6 screws (L).(FIG.4)
7. Lift the right side of the P.C.Board ass'y to remove the bottom base.

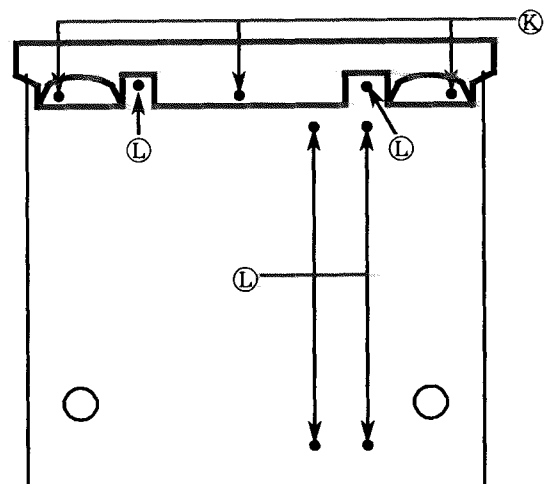

FIG.4 Bottom side

■ Front P.C. Board removal

1. Remove the top cover.
2. Remove the front panel assembly.
3. Remove the master volume knob and nut.
4. Remove 9 screws (M).(FIG.5)
5. Remove the front P.C. Board.

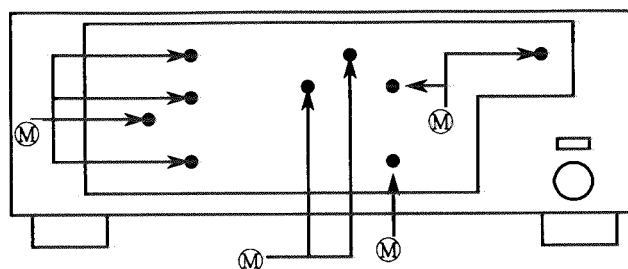

FIG.5 Front panel ass'y rear side

■ Power Transistor removal

1. Remove the top cover.
2. Remove the front panel assembly.
3. Remove the main amp. P.C.Board with same P.C.Board.
4. Unsolder the broken transistor.
5. Remove the some screws (N) fastening it.(FIG.6)

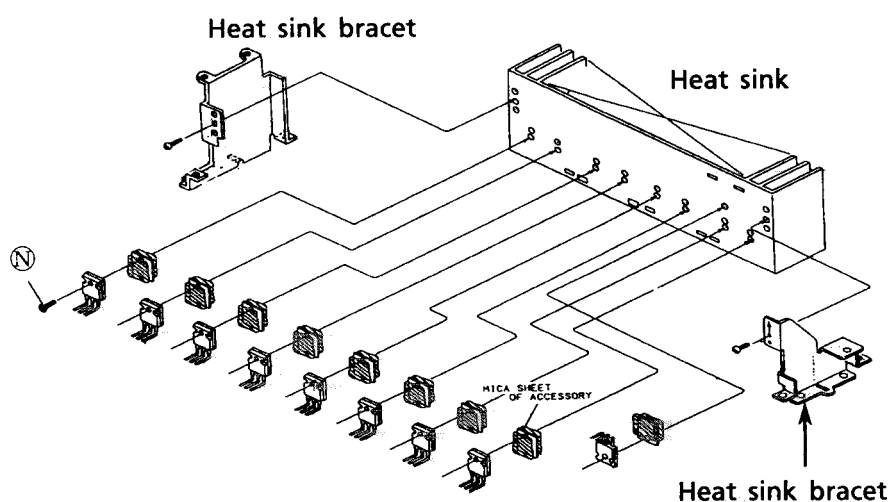
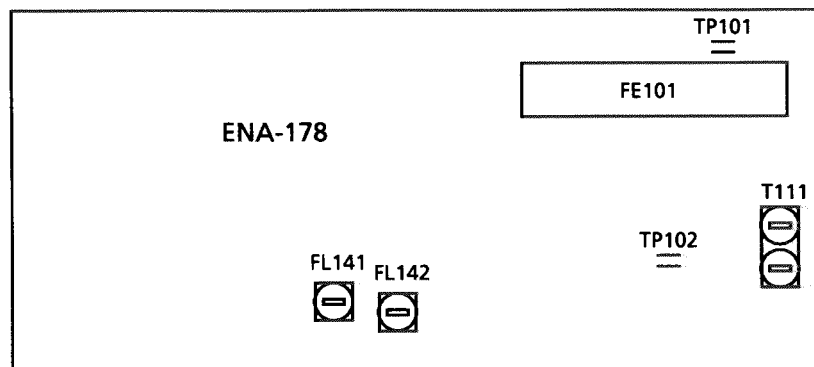

FIG.6

## ADJUSTMENT PROCEDURES

### ■ Tuner section



#### Tuning range

Area	Range		
	LW ( kHz)	MW (kHz)	FM (MHz)
Continental Europe, the U.K	144~288	522~1629	87.5~108.0

#### (1) Tuning Voltage

Confirm the voltages in the table at TP101.

##### FM Tuning voltage (Unit : V)

Area	Frequency	
	87.5MHz	108MHz
All Area	1.6±1.0	8.0±2.0

##### AM Tuning voltage (Unit : V)

Area	Frequency (MW)		Frequency (LW)	
	522KHz	1629KHz	144kHz	288kHz
the U.K. , Continental Europe	>0.7	<7.9	0.5 <1.0	5.0 <7.5

#### (2) FM Center meter

Receive a broadcast by using the function of 'AUTO STOP'.

Adjust T141 (Detector coil) so that the voltage at TP102 becomes  $0 \pm 1.5\text{mV}$ .



## ■ Power Amplifier section

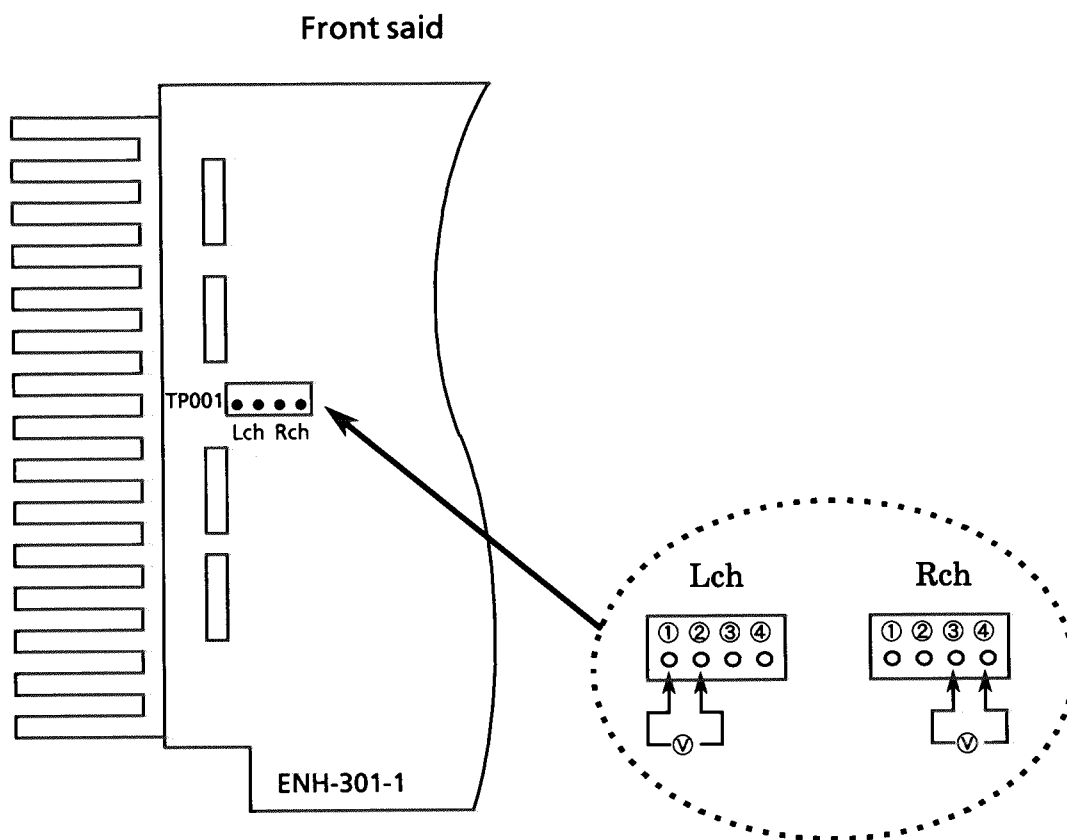

## ■ Idling current

- (1) Set the volume control to minimum during this adjustment.  
**\* Set the surround mode "ON".**
- (2) Turn VR741 and VR742 fully counterclockwise to warm up before adjustment.  
 If the heatsink is already warm from previous use the correct adjustment can not be made.
- (3) For L-ch, connect a DC voltmeter between TP001's pin1 and pin2 (Lch).  
 And, connect it between pin3 and pin4(Rch).
- (4) Appox. 30minutes later after power on, adjust VR741 for L-ch , or VR742 for R-ch so that the DC voltmeters value has 1mV~10mV.

### The Marks for Designated Areas

BS . . . .	the U.K.	EF . . . . .	Continental Europe	EN . . .	Nordic Countries
G . . . . .	Germany				

No mark indicates all area.

**-MEMO-**



# Block Diagrams

## Tuner Section

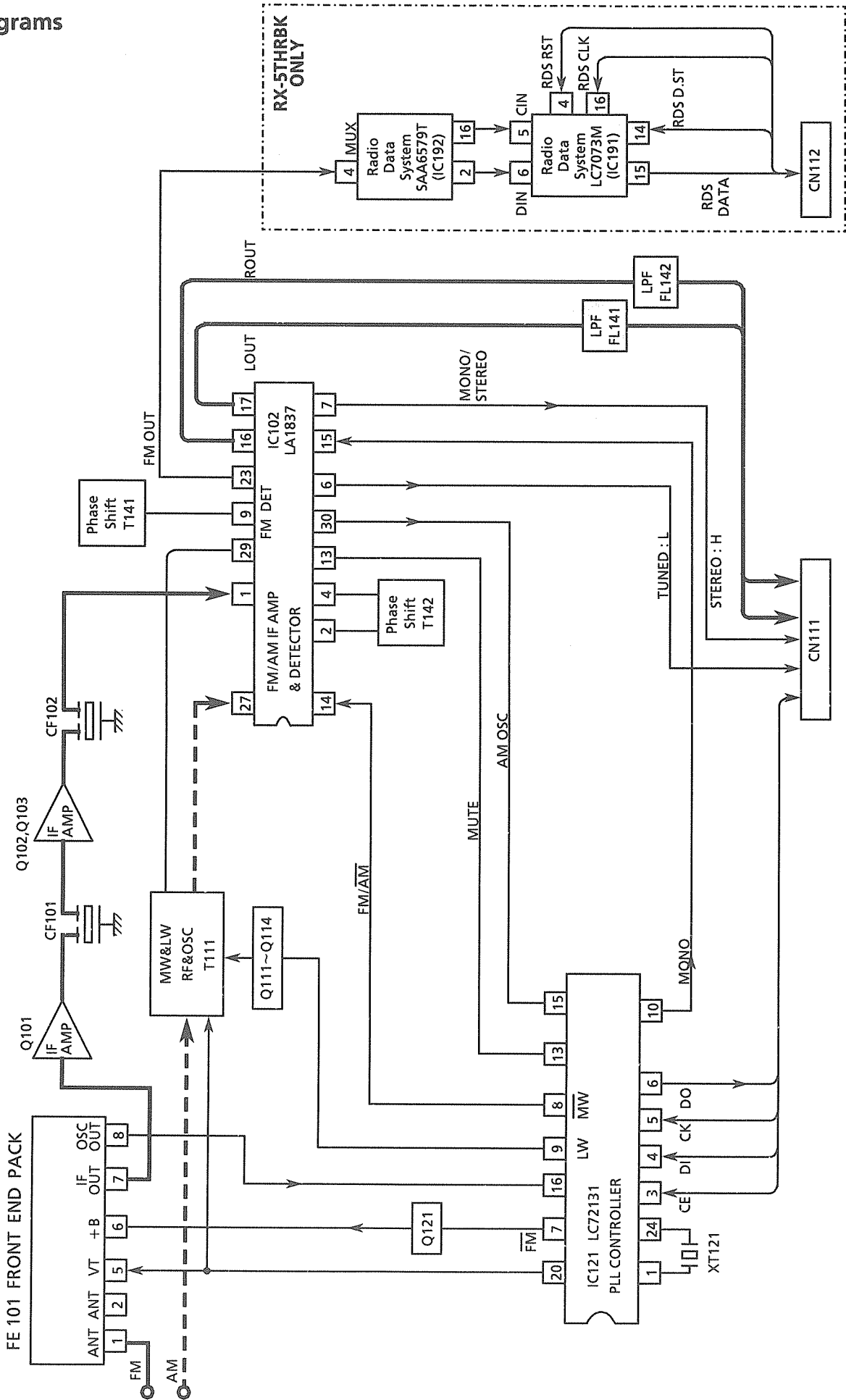

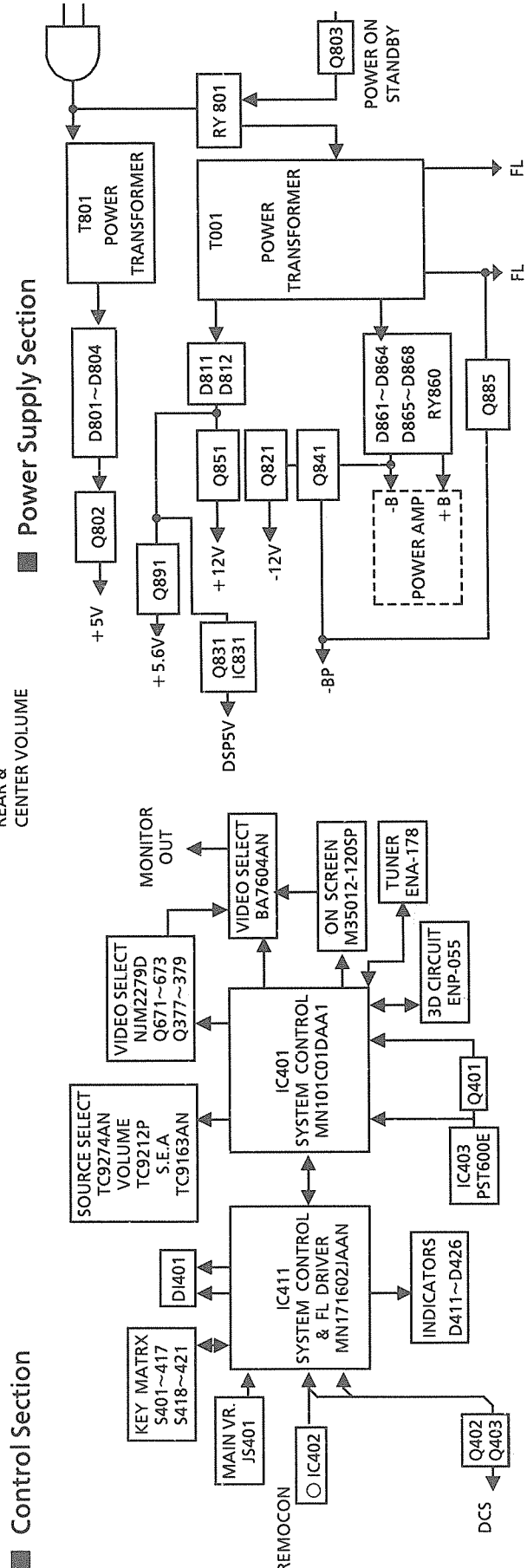
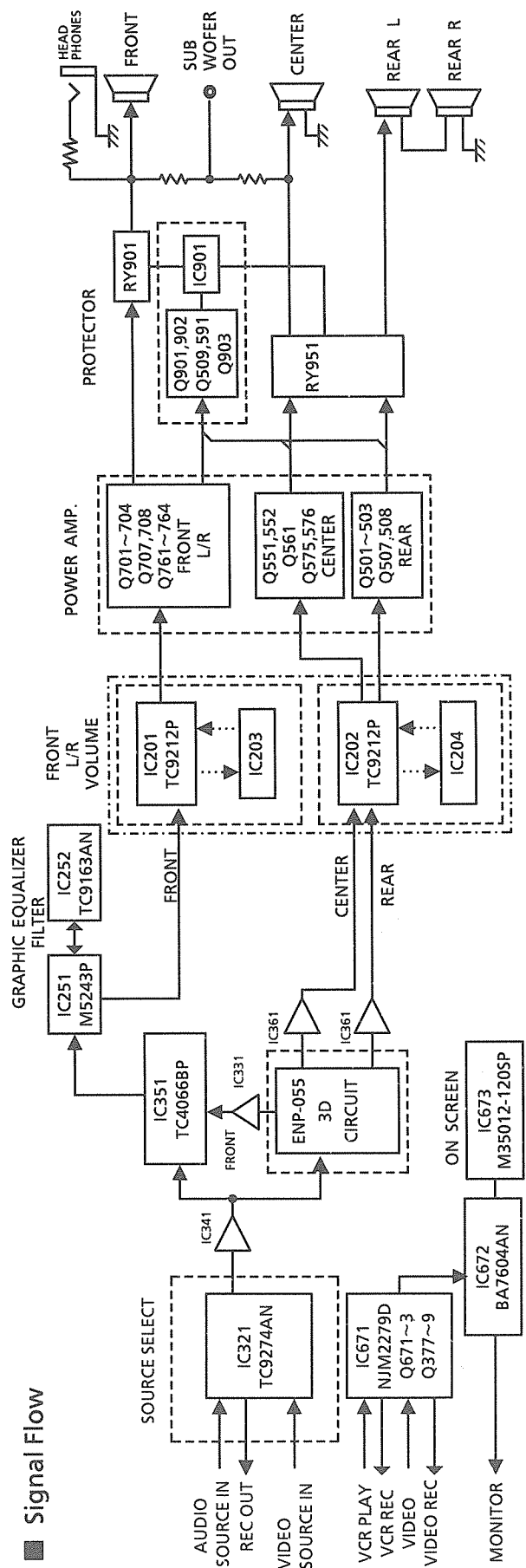

MAIN AMP. P.C.BORD(ENH-301)

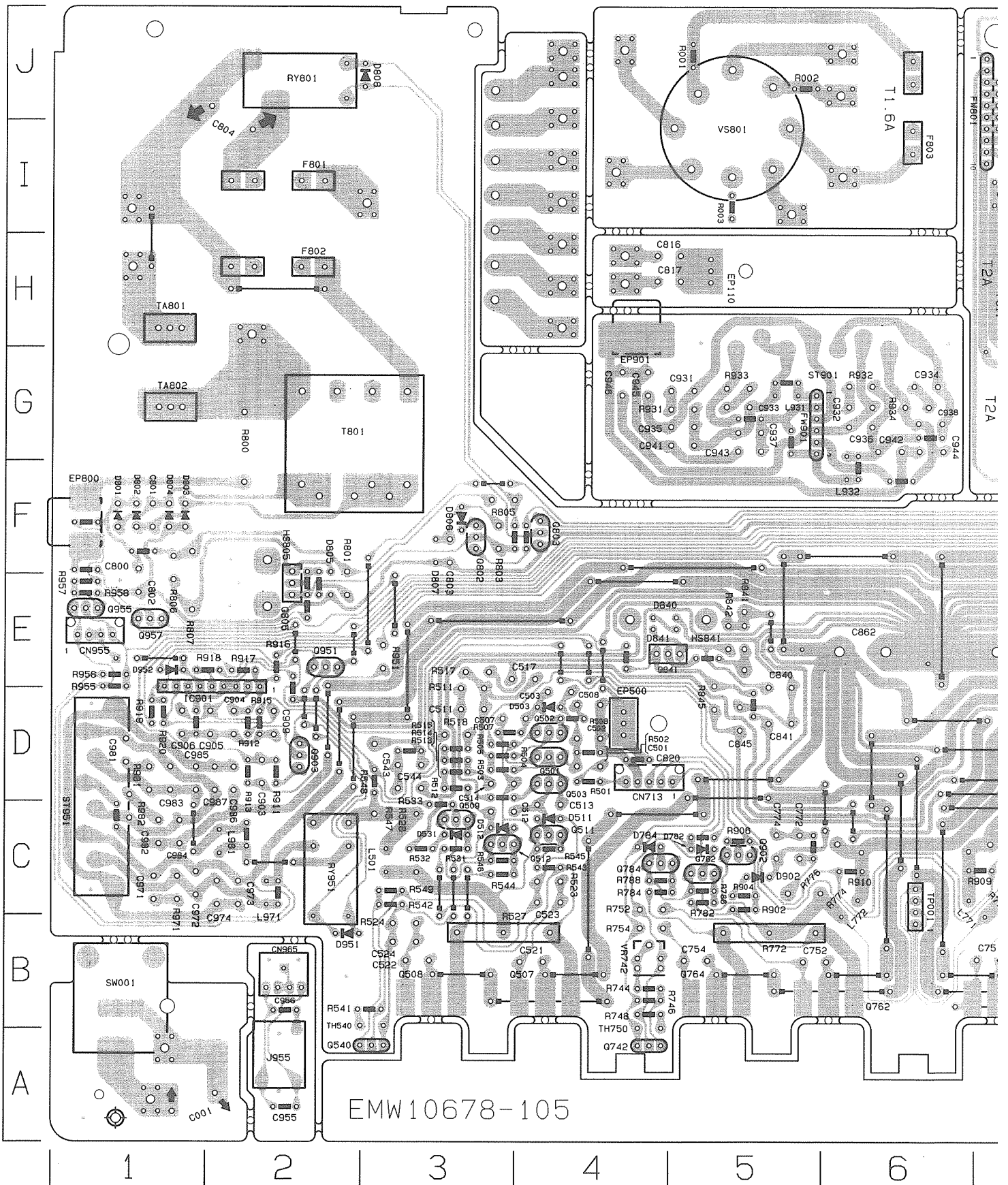

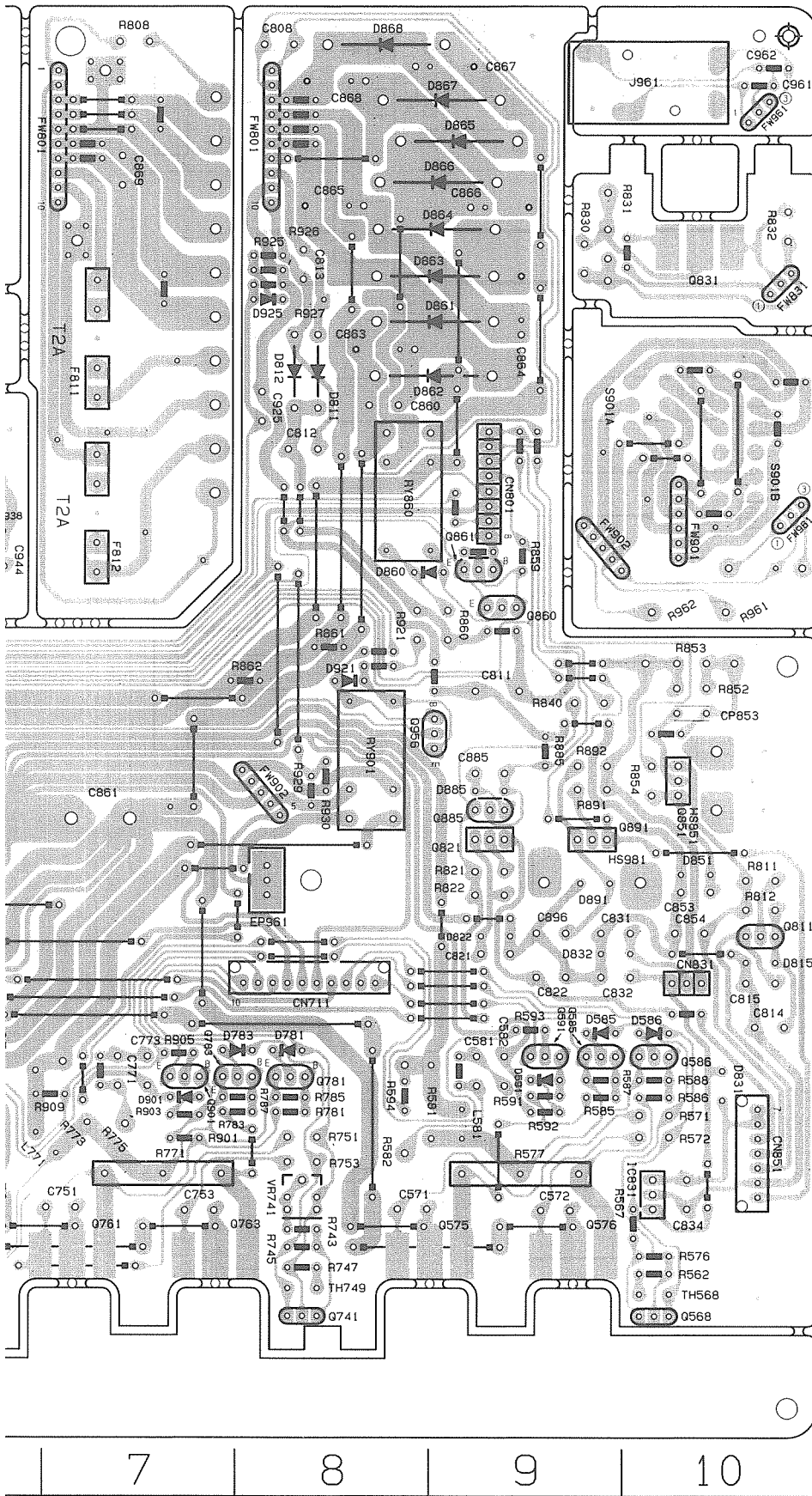

Location List (ENH-301)

Symbol	X	Y	Symbol	X	Y	Symbol	X	Y	Symbol	X	Y	Symbol	X	Y	Symbol	X	Y
C001	1	A	C932	6	G	D885	9	E	U902	5	C	R782	5	C	R801	2	J
C201	4	D	C933	5	G	D891	9	D	U903	2	D	R783	8	C	R860	8	G
C202	4	D	C934	6	G	D901	7	C	U951	2	E	R784	5	C	R950	8	F
C303	4	D	C935	5	G	D902	5	C	U955	1	E	R785	8	C	R951	2	B
C307	4	D	C936	6	G	D921	8	F	U956	9	F	R786	5	C	S901A	10	H
C508	4	D	C937	5	G	D925	8	H	U957	1	E	R787	7	C	S901B	10	H
C511	3	D	C938	6	G	D951	2	B	R001	5	J	R788	4	C	ST901	5	H
C512	3	C	C941	5	G	D952	1	E	R002	5	J	R800	2	F	ST951	1	D
C513	4	C	C942	6	G	F801	2	I	R003	5	I	R801	2	F	SW001	1	B
C514	3	D	C943	5	G	F802	2	H	R501	4	D	R803	3	F	T801	2	G
C517	3	D	C944	6	G	F803	6	I	R502	4	D	R805	3	F	T801	1	H
C521	4	B	C945	4	G	F811	7	H	R503	3	D	R806	1	F	T802	1	G
C522	3	B	C946	4	G	F812	7	H	R504	3	D	R807	1	F	TH540	3	B
C523	4	C	C955	2	A	F821	7	J	R505	3	D	R808	7	J	TH568	10	B
C524	3	B	C956	2	B	FW901	7	J	R507	4	D	R811	10	D	TH749	8	B
C543	3	D	C951	10	J	FW910	8	J	R508	4	D	R812	10	D	TH750	2	B
C544	3	D	C952	10	J	FW911	5	C	R509	3	D	R821	9	D	TP001	6	B
C571	8	B	C971	1	C	FW910	10	G	R512	3	D	R822	9	D			
C572	9	B	C972	1	C	FW902	9	E	R513	3	D	R830	9	I			
C581	9	C	C973	2	C	FW902B	9	D	R513	3	D	R831	9	I			
C582	9	C	C974	2	C	FW961	10	J	R514	3	D	R831	9	I			
G751	7	B	C981	1	D	FW961A	10	G	R515	3	D	R840	10	F			
G752	6	B	C982	1	C	IC831	10	B	R516	3	D	R841	9	F			
G753	7	B	C983	1	D	IC901	2	E	R523	4	C	R842	5	E			
G754	5	B	C984	1	C	J955	2	A	R524	3	D	R845	5	D			
G771	7	C	C985	1	D	J961	5	J	R527	3	D	R852	10	F			
G772	5	C	C986	2	D	L501	3	C	R528	3	C	R855	10	F			
G773	7	C	C987	2	D	L581	9	C	R531	3	C	R854	10	F			
G774	5	C	C9711	8	D	L771	7	B	R532	3	C	R859	9	D			
C800	1	F	C9713	5	D	L772	6	B	R533	3	C	R860	9	F			
C801	1	F	C9801	9	G	L931	5	G	R541	2	B	R861	8	F			
C802	1	F	C9831	10	D	L932	6	G	R542	3	C	R862	8	F			
C803	3	F	C9851	10	C	L971	2	C	R543	4	C	R865	9	E			
C804	2	I	C9855	1	E	L981	2	C	R544	4	C	R891	9	E			
C808	8	J	C9865	2	B	O501	4	D	R545	4	C	R892	9	E			
C811	3	F	C9903	4	D	O502	4	D	R546	3	C	R901	7	C			
C812	8	G	O511	4	C	O503	4	D	R547	3	C	R902	5	C			
C813	8	I	O512	3	C	O507	4	D	R548	3	C	R903	7	C			
C814	10	C	O531	3	C	O508	3	B	R549	3	C	R904	5	C			
C815	10	D	O585	9	C	O509	3	C	R562	10	B	R905	7	C			
C816	5	H	O586	10	C	O511	4	C	R567	10	B	R906	5	C			
C817	5	H	O591	9	C	O512	3	C	R571	10	C	R909	7	C			
C820	4	D	O781	8	C	O540	3	A	R572	10	C	R910	6	C			
C821	9	D	O782	5	C	O568	10	A	R576	10	B	R911	2	D			
C822	9	D	O783	7	C	O575	8	B	R577	9	B	R912	2	D			
C831	10	D	O784	4	C	O576	9	B	R581	9	C	R913	2	D			
C832	10	D	O601	1	F	O585	9	C	R582	8	B	R915	2	D			
C834	10	B	O602	1	F	O586	10	C	R585	9	C	R916	2	E			
C840	5	B	O603	1	F	O591	9	C	R586	10	C	R917	2	E			
C841	5	D	O604	1	F	O741	8	A	R587	9	C	R918	2	E			
C845	5	D	O605	2	E	O742	4	A	R588	10	C	R919	1	D			
C853	10	D	O606	3	F	O761	6	B	R591	9	C	R920	1	D			
C854	10	D	O607	3	F	O762	5	B	R592	9	C	R921	8	F			
C880	8	H	O608	3	J	O763	7	B	R593	9	C	R925	8	I			
C861	7	E	D811	8	H	O754	5	B	R594	8	C	R926	8	I			
C862	6	E	D812	8	H	O781	8	C	R743	8	B	R927	8	I			
C863	8	H	D815	10	D	O782	5	C	R744	4	A	R929	2	B			
C864	9	H	D822	5	D	O783	8	C	R745	8	B	R930	8	E			
C865	8	I	D831	10	C	O784	5	C	R746	4	A	R931	5	G			
C866	9	I	D832	9	D	O802	3	F	R747	8	B	R932	6	G			
C867	8	J	D840	4	E	O803	4	F	R748	4	B	R933	5	G			
C868	8	J	D841	4	E	O805	2	E	R751	8	C	R934	3	G			
C869	7	I	D851	10	D	O811	10	D	R752	4	C	R951	3	E			
C885	9	E	D860	9	G	O821	9	E	R753	8	B	R955	1	E			
C896	9	D	D861	9	H	O831	10	I	R754	4	B	R956	1	E			
C903	2	D	D862	9	H	O841	4	E	R771	7	B	R957	1	E			
C904	2	D	D863	9	I	O851	10	E	R772	5	B	R958	1	E			
C905	2	D	D864	9	I	O860	9	F	R773	7	C	R961	10	F			
C906	1	D	D865	9	J	O861	9	G	R774	5	C	R962	10	F			
C909	2	D	D866	9	I	O885	9	E	R775	7	C	R971	1	D			
C925	8	H	D867	9	J	O891	9	E	R776	5	C	R981	1	D			
C931	5	G	D868	9	J	O901	7	C	R781	8	C	R982	1	C			

7                      8                      9                      10

# INPUT P.C. BOARD (ENC-135)

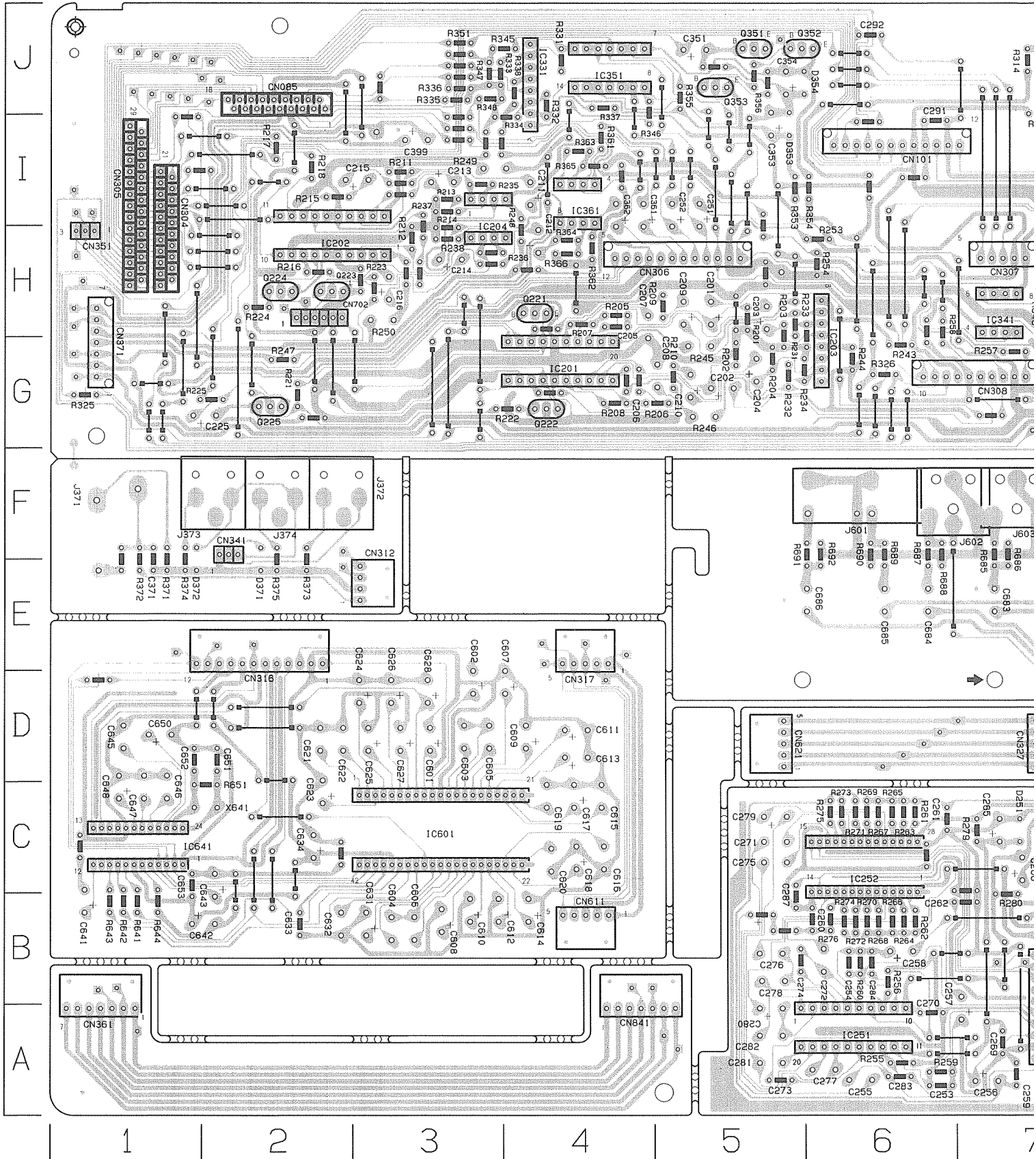



Location List (ENC-135)

Symbol	X	Y	Symbol	X	Y	Symbol	X	Y	Symbol	X	Y	Symbol	X	Y	Symbol	X	Y
C201	5	H	C320	10	I	C662	9	C	J371	1	F	R258	6	H	R386	10	G
C202	5	G	C321	10	H	C663	8	B	J372	2	F	R259	6	A	R387	10	F
C203	5	H	C323	7	I	C664	8	C	J373	2	F	R260	6	B	R388	10	F
C204	5	G	C324	8	G	C665	8	C	J374	2	F	R261	6	C	R389	10	E
C205	4	H	C325	8	G	C667	8	B	J601	6	F	R262	6	B	R390	10	E
C206	4	G	C341	7	H	C668	8	A	J602	6	F	R263	6	C	R393	10	H
C207	4	G	C342	7	G	C671	9	C	J603	7	F	R264	6	B	R394	10	H
C208	5	G	C351	5	J	C672	8	E	J604	8	F	R265	6	C	R395	10	G
C209	5	H	C353	5	I	C673	8	D	L661	8	B	R266	6	B	R396	10	G
C210	5	G	C354	5	J	C674	8	B	L671	9	C	R267	6	C	R397	10	F
C211	4	I	C361	4	H	C675	8	A	O221	4	H	R268	6	B	R398	10	E
C212	4	H	C362	4	H	C676	8	D	O222	4	H	R269	6	C	R641	1	B
C213	3	I	C371	1	E	C681	8	E	O223	2	G	R270	6	B	R642	1	B
C214	3	H	C381	10	I	C682	7	E	O224	2	H	R271	6	C	R643	1	B
C215	2	I	C382	10	H	C683	7	E	O225	2	H	R272	6	B	R644	1	B
C216	3	H	C385	10	G	C684	6	E	O351	5	J	R273	6	C	R651	2	C
C225	1	G	C386	10	G	C685	5	E	O352	5	J	R274	6	B	R661	8	B
C251	5	H	C387	10	F	C686	5	E	O353	5	J	R275	6	C	R662	8	B
C252	5	H	C388	10	F	C688	2	J	O671	7	E	R276	6	B	R663	8	B
C253	6	A	C389	10	E	C691	7	I	O672	8	D	R279	7	C	R671	7	E
C254	6	B	C390	10	E	C692	10	C	O673	8	D	R280	7	B	R672	8	E
C255	6	A	C393	10	H	C694	1	H	O674	8	D	R301	10	J	R673	8	E
C256	7	A	C394	10	H	C695	1	H	O675	8	D	R302	10	I	R674	8	D
C257	7	A	C395	10	G	C696	5	H	O677	8	F	R303	9	J	R675	8	D
C258	6	B	C396	10	G	C697	7	H	O678	8	F	R304	9	J	R676	8	C
C259	7	A	C397	10	F	C698	7	H	O679	9	F	R305	9	J	R677	8	F
C260	6	B	C398	10	E	C699	3	I	O691	5	H	R306	9	I	R678	8	F
C261	6	C	C399	3	I	C6916	2	E	R202	5	G	R307	9	J	R679	8	F
C262	6	B	C601	3	D	C6917	4	E	R203	5	G	R308	8	I	R681	8	F
C265	7	C	C602	3	D	C6918	7	A	R204	5	H	R309	8	F	R682	8	F
C266	7	C	C603	3	D	C6927	7	D	R205	4	G	R310	8	I	R683	7	F
C269	7	A	C604	3	B	C6941	2	F	R206	5	G	R311	7	J	R684	7	E
C270	6	A	C605	3	D	C6951	1	H	R207	4	H	R312	8	I	R685	7	F
C271	5	C	C605	3	B	C6961	1	A	R208	4	G	R313	7	J	R686	7	F
C272	6	B	C607	4	D	C6971	1	G	R209	5	H	R314	7	J	R687	6	F
C273	5	A	C608	3	B	C6981	8	A	R210	5	G	R325	1	G	R688	6	E
C274	5	B	C609	4	D	C6982	8	A	R211	5	G	R326	6	B	R689	6	F
C275	5	C	C610	3	B	C6983	9	A	R212	3	H	R331	4	J	R690	6	E
C276	5	B	C611	4	D	C6984	4	B	R213	3	H	R332	4	J	R691	6	F
C277	6	A	C612	3	B	C6982	5	D	R214	3	H	R333	3	J	R692	6	F
C278	5	B	C613	4	D	C6982	2	H	R215	2	I	R334	3	J	R693	9	D
C279	5	C	C614	4	B	C6984	5	A	R216	2	H	R335	3	J	R694	8	C
C280	5	A	C615	4	C	D251	7	C	R217	2	I	R336	3	J	R695	8	C
C281	5	A	C616	4	C	D252	7	C	R218	2	I	R337	4	J	R696	8	C
C282	5	A	C617	4	C	D253	5	J	R221	2	C	R338	4	J	R697	8	C
C283	6	A	C618	4	C	D254	5	J	R222	4	C	R341	7	H	R698	8	C
C284	6	B	C619	4	C	D301	2	E	R223	3	H	R342	7	H	R699	8	C
C287	5	B	C620	4	C	D372	1	E	R224	3	H	R343	7	H	R700	8	C
C291	6	J	C621	2	D	D671	8	D	R225	2	G	R344	7	H	R701	8	C
C292	6	J	C622	2	D	D672	8	D	R231	5	H	R345	4	J	R702	8	C
C295	10	H	C623	2	C	D673	8	A	R232	5	H	R346	4	J	R703	8	C
C296	10	G	C624	3	D	IC201	4	G	R233	6	G	R347	3	J	R704	8	C
C297	10	F	C625	3	D	IC202	3	H	R234	5	G	R348	3	J	R705	8	C
C298	10	F	C626	3	D	IC203	6	G	R235	3	I	R351	3	J	R706	8	C
C300	10	I	C627	3	D	IC204	3	I	R236	3	H	R352	5	J	R707	8	C
C301	10	J	C628	3	D	IC251	5	A	R237	3	I	R353	6	J	R708	8	C
C302	9	J	C631	3	B	IC252	6	C	R238	3	H	R355	5	J	R709	8	C
C303	9	J	C632	2	B	IC261	8	J	R241	7	I	R356	5	J	R710	8	C
C304	9	J	C633	2	B	IC321	8	H	R242	7	G	R361	4	I	R711	8	C
C305	9	J	C634	2	C	IC331	4	J	R243	6	G	R362	4	H	R712	8	C
C306	9	I	C641	1	B	IC341	7	H	R244	6	G	R363	4	H	R713	8	C
C307	8	J	C642	1	B	IC351	4	J	R245	5	C	R364	4	H	R714	8	C
C308	8	I	C643	2	B	IC361	4	I	R246	5	C	R365	4	H	R715	8	C
C309	8	J	C645	1	D	IC601	3	C	R247	2	C	R366	4	H	R716	8	C
C310	9	J	C646	1	D	IC641	1	C	R248	4	C	R371	1	F	R717	8	C
C311	8	J	C647	1	D	IC671	8	E	R249	4	H	R372	1	F	R718	8	C
C312	8	I	C648	1	C	IC672	8	C	R250	3	H	R373	2	E	R719	8	C
C313	9	J	C650	1	D	IC673	8	B	R253	6	A	R381	10	I	R720	8	C
C314	9	J	C651	2	D	J301	10	H	R254	6	A	R382	10	H	R721	8	C
C315	7	I	C652	1	D	J302	10	D	R255	6	A	R381	10	I	R722	8	C
C316	7	J	C653	1	B	J304	10	E	R256	6	B	R382	10	H	R723	8	C
C319	10	J	C661	9	C	J306	10	J	R257	7	G	R385	10	G	R724	8	C

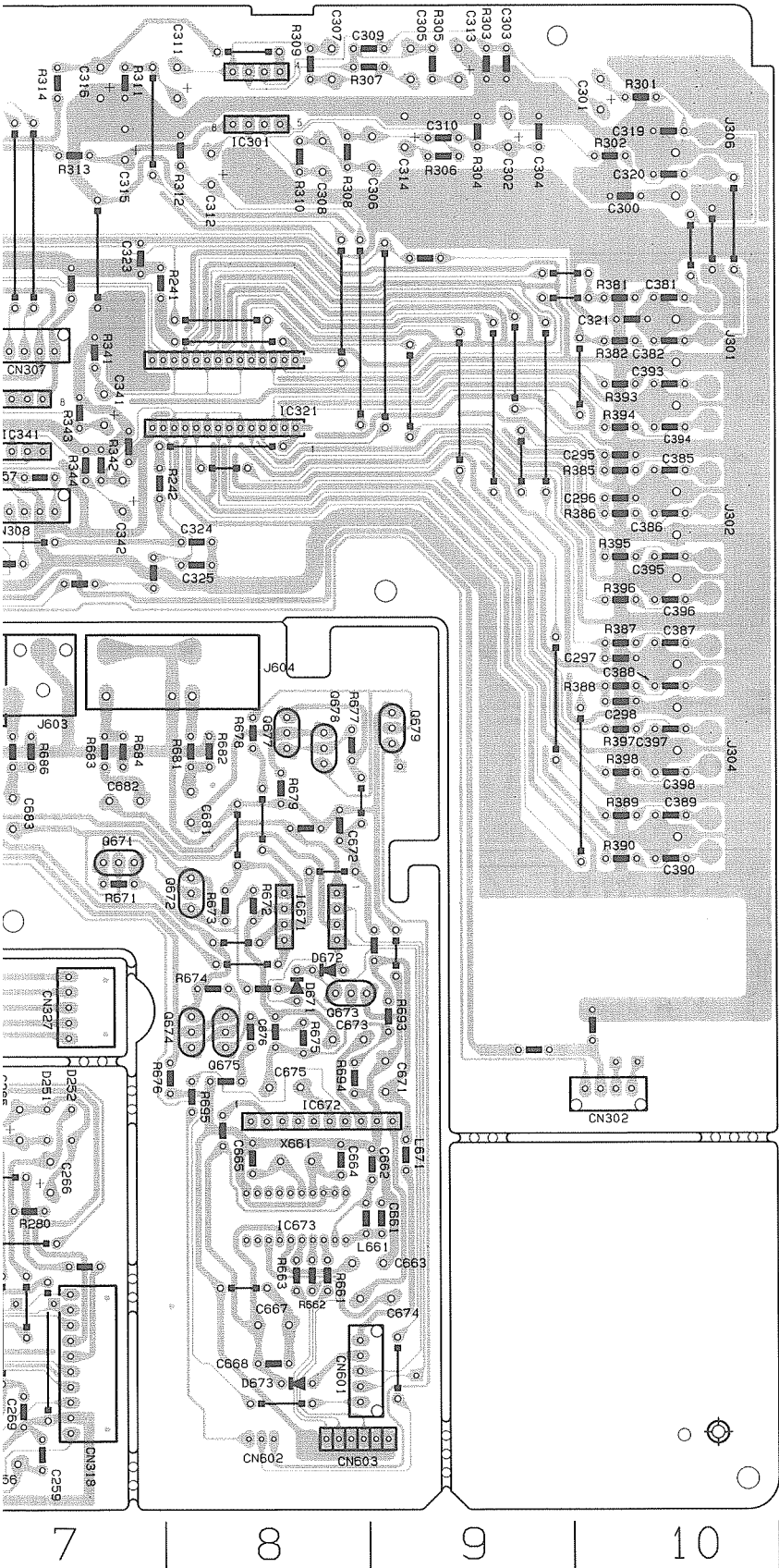

FRONT P.C.BOARD (ENB-245)

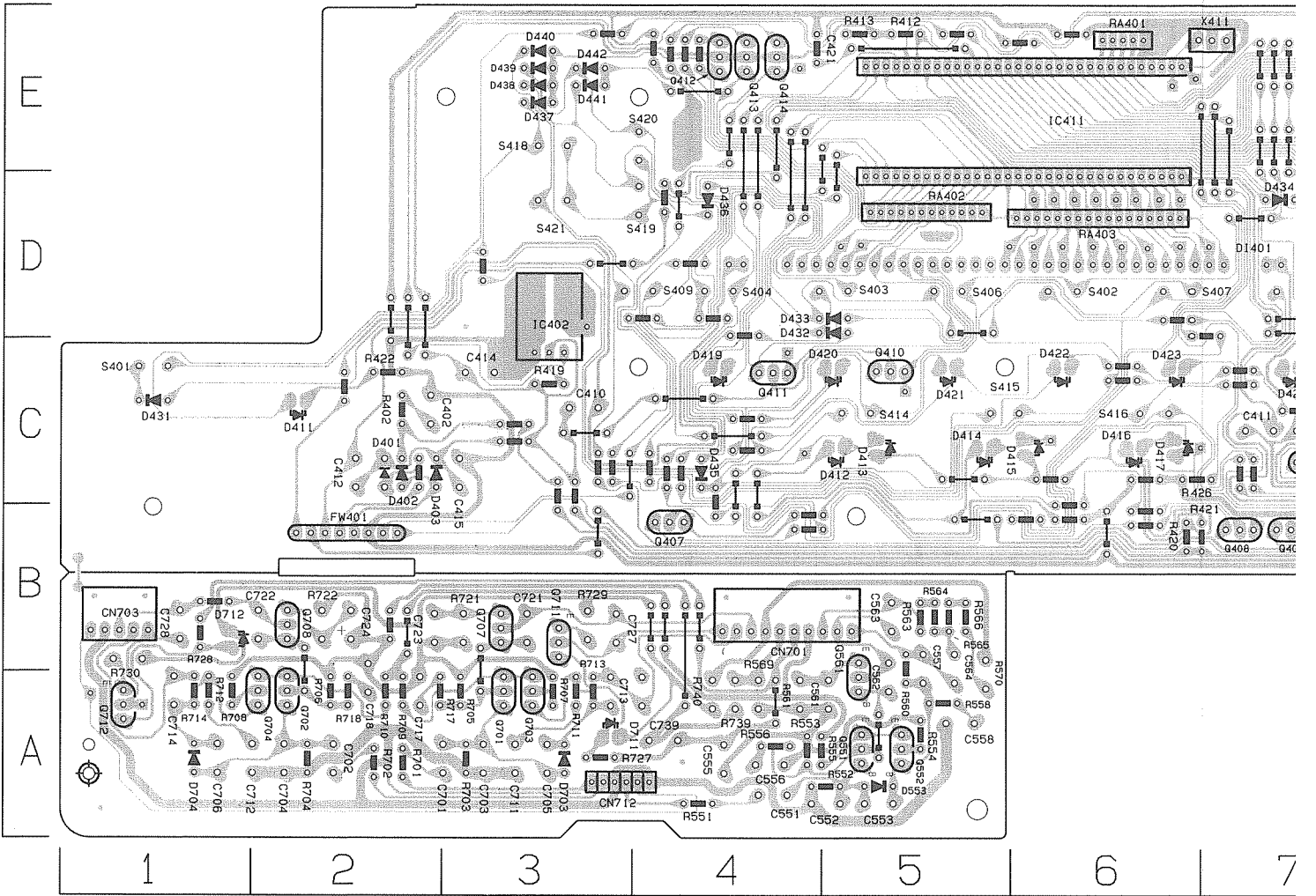

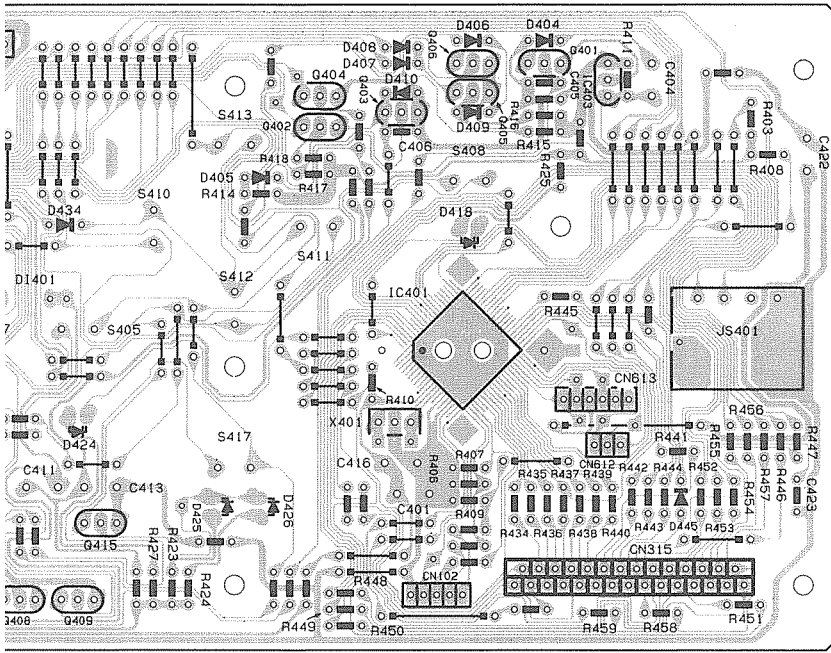

Location List (ENB-245)

Symbol	X	Y	Symbol	X	Y	Symbol	X	Y	Symbol	X	Y
C401	8	C	D421	5	C	R419	3	C	R739	4	A
C402	2	C	D422	6	C	R420	6	B	R740	4	A
C404	10	E	D423	6	C	R421	7	B	RA401	6	E
C405	9	E	D424	7	C	R422	2	C	RA402	5	D
C406	8	E	D425	8	C	R423	7	B	RA403	6	D
C410	3	C	D426	8	C	R424	7	B	S401	1	C
C411	7	C	D431	1	C	R425	9	E	S402	6	D
C412	2	C	D432	5	D	R426	7	C	S403	5	D
C413	7	C	D433	5	D	R427	7	B	S404	4	D
C414	3	C	D434	7	D	R434	9	C	S405	7	D
C415	3	C	D435	4	C	R435	9	C	S406	5	D
C416	9	C	D436	4	D	R436	9	C	S407	6	D
C421	4	E	D437	3	E	R437	9	C	S408	9	E
C422	10	E	D438	3	E	R438	9	C	S409	4	D
C423	10	C	D439	3	E	R439	9	C	S410	7	D
C551	4	A	D440	3	E	R440	9	C	S411	8	D
C552	5	A	D441	3	E	R441	10	C	S412	8	D
C553	5	A	D442	3	E	R442	10	C	S413	8	E
C555	4	A	D445	10	C	R443	10	C	S414	5	C
C556	4	A	D553	5	A	R444	10	C	S415	5	C
C557	5	A	D703	3	A	R445	9	D	S416	6	C
C558	5	A	D704	1	A	R446	10	C	S417	8	C
C561	5	A	D711	3	A	R447	10	C	S418	3	E
C562	5	A	D712	1	B	R448	8	B	S419	4	D
C563	5	B	D1401	7	D	R449	8	B	S420	4	E
C564	5	A	FW401	2	B	R450	8	B	S421	3	D
C701	3	A	IC401	9	D	R451	10	B	X401	8	C
C702	2	A	IC402	3	D	R452	10	C	X411	7	E
C703	3	A	IC403	9	E	R453	10	C			
C704	2	A	IC411	6	D	R454	10	C			
C705	3	A	JS401	10	D	R455	10	C			
C706	1	A	Q401	9	E	R456	10	C			
C711	3	A	Q402	8	E	R457	10	C			
C712	2	A	Q403	8	E	R458	10	B			
C713	3	A	Q404	8	E	R459	9	B			
C714	1	A	Q405	9	E	R551	4	A			
C717	2	A	Q406	9	E	R552	4	A			
C718	2	B	Q407	4	B	R553	4	A			
C721	3	B	Q408	7	B	R554	5	A			
C722	2	B	Q409	7	B	R555	4	A			
C723	2	B	Q410	5	C	R556	4	A			
C724	2	B	Q411	4	C	R558	5	A			
C727	3	B	Q412	4	E	R560	5	A			
C728	1	B	Q413	4	E	R561	4	A			
C739	4	A	Q414	4	E	R563	5	B			
CN102	9	B	Q415	7	C	R564	5	B			
CN315	10	B	Q551	5	A	R565	5	B			
CN612	9	C	Q552	5	A	R566	5	B			
CN613	9	C	Q561	5	A	R569	4	A			
CN701	5	B	Q701	3	A	R570	5	B			
CN703	1	B	Q702	2	A	R701	2	A			
CN712	4	A	Q703	3	A	R702	2	A			
D401	2	C	Q704	2	A	R703	3	A			
D402	2	C	Q707	3	B	R704	2	A			
D403	2	C	Q708	2	B	R705	3	A			
D404	9	E	Q711	3	B	R706	2	A			
D405	8	E	Q712	1	A	R707	3	A			
D406	9	E	R402	2	C	R708	1	A			
D407	8	E	R403	10	E	R709	2	A			
D408	8	E	R406	9	C	R710	2	A			
D409	9	E	R407	9	C	R711	3	A			
D410	9	E	R408	10	E	R712	1	A			
D411	2	C	R409	9	C	R713	3	A			
D412	5	C	R410	8	D	R714	1	A			
D413	5	C	R411	10	E	R717	2	A			
D414	5	C	R412	5	E	R718	2	A			
D415	6	C	R413	5	E	R721	3	B			
D416	6	C	R414	8	D	R722	2	B			
D417	6	C	R415	9	E	R727	3	A			
D418	9	D	R416	9	E	R728	1	B			
D419	4	C	R417	8	E	R729	3	B			
D420	5	C	R418	8	E	R730	1	B			

# TUNER P.C.BOARD (ENA-178)

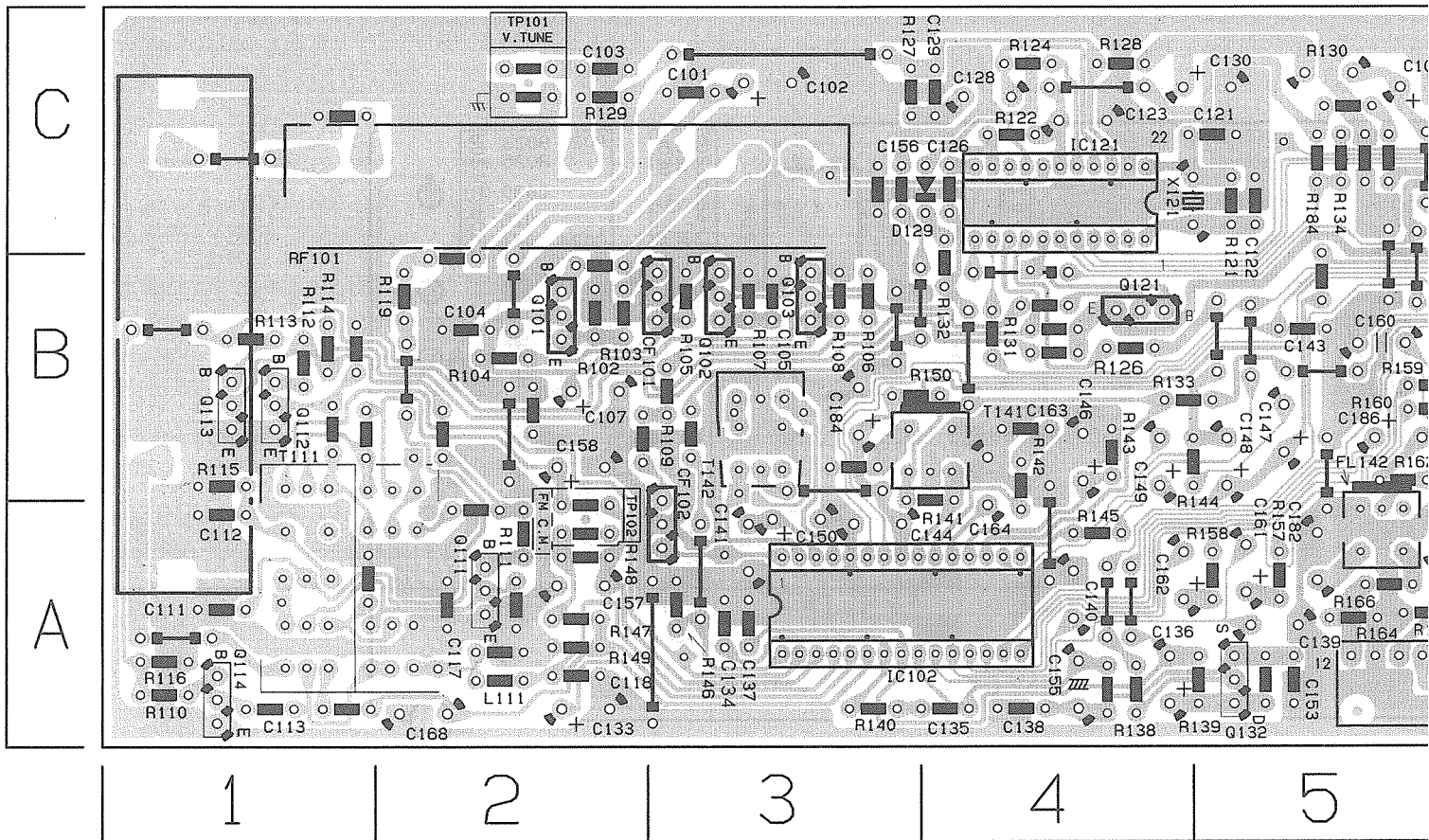

Location List (ENA-178)

Symbol	X	Y	Symbol	X	Y	Symbol	X	Y
C101	3	C	C191	8	B	R139	5	A
C102	3	C	C192	8	C	R140	3	A
C103	2	C	C193	8	C	R141	3	A
C104	2	B	C194	8	C	R142	4	B
C105	3	B	C195	7	B	R143	4	B
C107	2	B	C196	8	B	R144	4	B
C109	5	C	C197	7	B	R145	4	A
C111	1	A	C199	8	C	R146	3	A
C112	1	A	CF101	3	B	R147	2	A
C113	1	A	CF102	3	A	R148	2	A
C117	2	A	CN111	5	A	R149	2	A
C118	2	A	CN112	8	C	R150	4	B
C121	4	C	D121	6	B	R151	7	B
C122	5	C	D122	7	B	R152	7	A
C123	4	C	D123	6	A	R153	7	A
C126	4	C	D124	6	B	R155	7	B
C128	4	C	D129	4	C	R156	7	B
C129	4	C	D130	6	C	R157	5	A
C130	4	C	D131	6	A	R158	5	A
C131	7	B	D132	7	B	R159	5	B
C132	7	A	D133	6	C	R160	5	B
C133	2	A	FL141	6	A	R161	6	B
C134	3	A	FL142	5	A	R162	5	B
C135	3	A	IC102	3	A	R163	5	A
C136	4	A	IC104	8	A	R164	5	A
C137	3	A	IC121	4	C	R165	5	A
C138	4	A	IC191	7	C	R166	5	A
C139	5	A	IC192	8	B	R167	6	C
C140	4	A	L111	2	A	R168	6	C
C141	3	A	Q101	2	B	R170	7	A
C143	5	B	Q102	3	B	R171	7	A
C144	3	A	Q103	3	B	R172	7	A
C146	4	B	Q111	2	A	R173	7	A
C147	5	B	Q112	1	B	R176	7	B
C148	5	B	Q113	1	B	R177	8	B
C149	4	B	Q114	1	A	R178	8	A
C150	3	A	Q121	4	B	R179	8	A
C153	5	A	Q123	6	C	R181	6	C
C154	7	B	Q131	7	B	R182	6	A
C155	4	A	Q132	5	A	R183	6	A
C156	3	C	Q133	6	C	R184	5	C
C157	2	A	Q134	6	C	R191	8	C
C158	2	B	R102	2	B	RF101	1	C
C159	6	B	R103	2	B	T111	2	A
C160	5	B	R104	2	B	T141	4	B
C161	5	A	R105	3	B	T142	3	B
C162	4	A	R106	3	B	T151	7	A
C163	4	B	R107	3	B	TC101	7	A
C164	4	A	R108	3	B	X121	4	C
C165	6	C	R109	3	B	X191	8	B
C166	7	A	R110	1	A	X192	7	C
C167	8	A	R111	2	A			
C168	2	A	R112	1	B			
C170	7	B	R113	1	B			
C171	7	A	R114	1	B			
C172	7	A	R115	1	B			
C173	8	A	R116	1	A			
C174	8	B	R119	2	B			
C177	8	B	R121	5	C			
C178	8	B	R122	4	C			
C179	8	B	R124	4	C			
C180	6	B	R126	4	B			
C181	5	A	R127	3	C			
C182	5	A	R128	4	C			
C183	6	C	R129	2	C			
C184	3	B	R130	5	C			
C185	6	B	R131	4	B			
C186	5	B	R132	4	C			
C187	7	A	R133	5	B			
C188	8	B	R134	5	C			
C189	8	A	R137	5	C			
C190	8	A	R138	4	A			

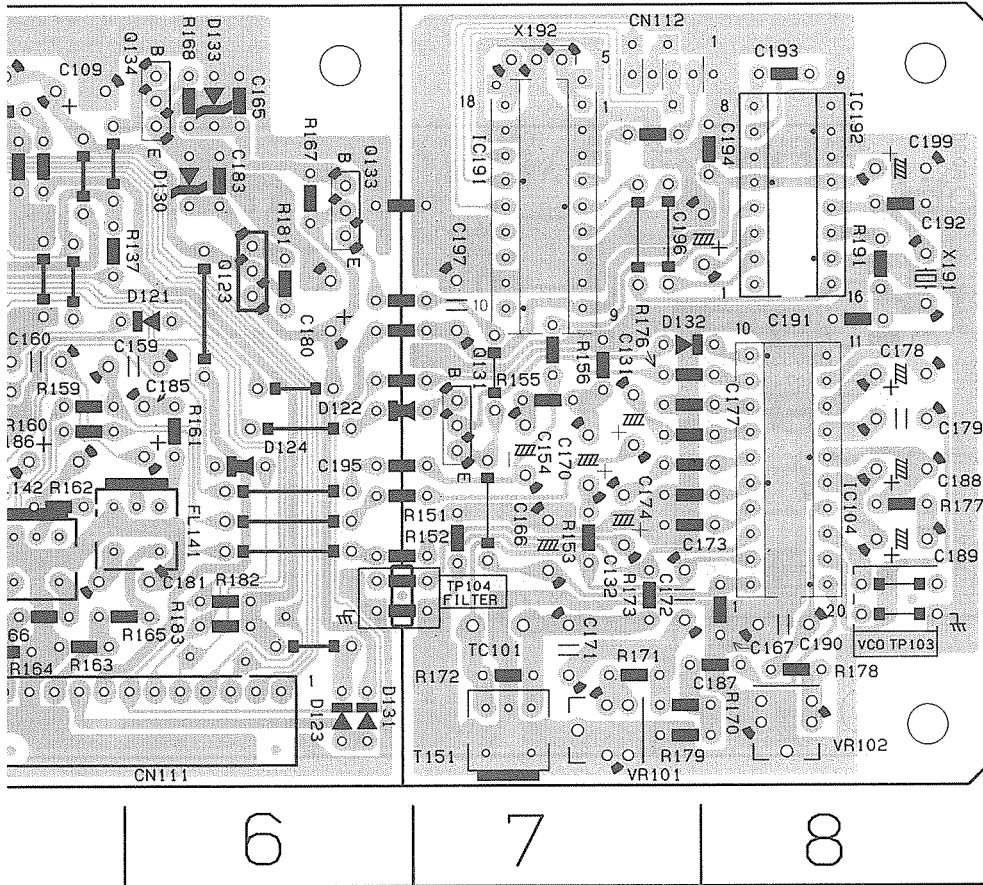

3D Phonic P.C.board (ENP-055)

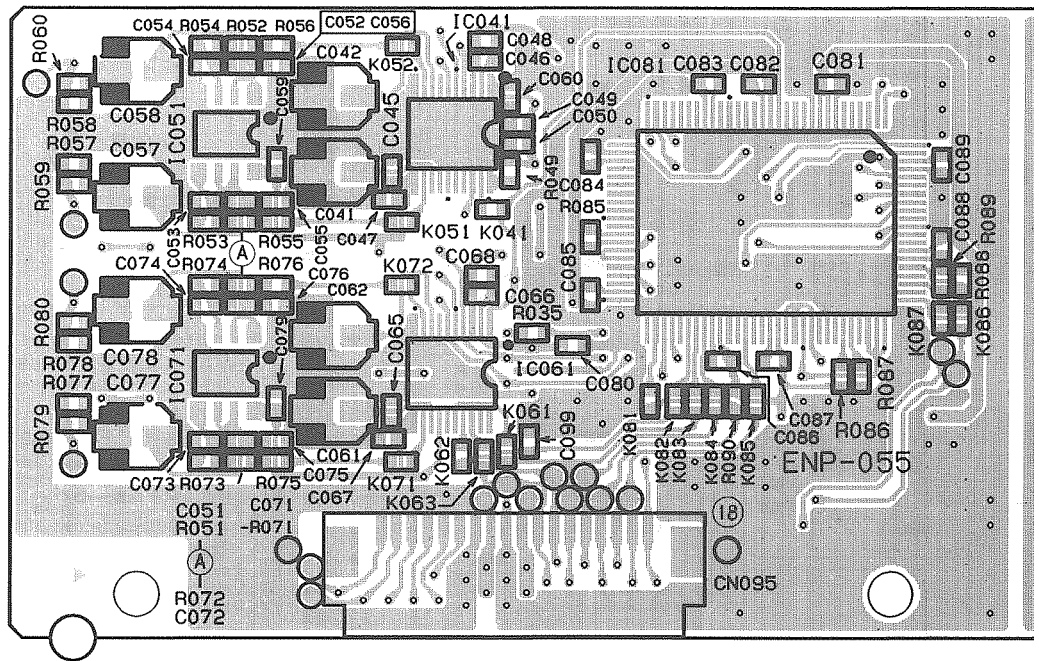

Location List (ENP-055)

Symbol	X	Y	Symbol	X	Y	Symbol	X	Y	Symbol	X	Y	Symbol	X	Y	Symbol	X	Y
C021	8	C	C055	2	C	C086	3	B	K062	2	B	R031	7	B	R085	3	C
C022	8	B	C056	2	C	C087	4	B	K063	2	B	R035	3	B	R086	4	B
C023	7	B	C057	1	C	C088	4	B	K071	2	B	R049	2	C	R087	4	B
C024	7	B	C058	1	C	C089	4	C	K072	2	B	R051	1	C	R088	4	B
C025	7	C	C059	2	C	C091	6	C	K081	3	B	R052	1	C	R089	4	B
C026	7	B	C060	2	C	C092	6	C	K082	3	B	R053	1	C	R090	3	B
C027	7	B	C061	2	B	C094	6	A	K083	3	B	R054	1	C	X041	7	C
C028	7	B	C062	2	B	C095	7	A	K084	3	B	R055	2	C			
C029	7	B	C065	2	B	C096	6	A	K085	3	B	R056	2	C			
C030	8	B	C066	2	B	C097	7	A	K086	4	B	R057	1	C			
C031	7	B	C067	2	B	C098	6	A	K087	4	B	R058	1	C			
C035	7	C	C068	2	B	C099	3	B	K095	7	A	R059	1	C			
C036	7	B	C071	1	B	C100	6	A	K096	6	A	R080	1	C			
C037	7	C	C072	1	B	CN095	2	A	LC031	7	B	R071	1	B			
C038	6	B	C073	1	B	IC031	7	B	LC041	6	B	R072	1	B			
C041	2	C	C074	1	B	IC041	2	C	LC081	6	A	R073	1	B			
C042	2	C	C075	2	B	IC051	1	C	LC091	5	C	R074	1	B			
C045	2	C	C076	2	B	IC061	2	B	R021	8	B	R075	2	B			
C046	2	C	C077	1	B	IC071	1	B	R022	8	B	R076	2	B			
C047	2	C	C078	1	B	IC081	4	C	R023	8	B	R077	1	B			
C048	2	C	C079	2	B	IC091	5	C	R024	8	B	R078	1	B			
C049	3	C	C080	3	B	K021	8	B	R025	8	B	R079	1	B			
C050	3	C	C081	4	C	K022	8	B	R026	8	B	R080	1	B			
C051	1	C	C082	3	C	K042	6	B	R027	7	B	R081	6	B			
C052	1	C	C083	3	C	K051	2	C	R028	7	B	R082	6	B			
C053	1	C	C084	3	C	K052	2	C	R029	7	B	R083	6	B			
C054	1	C	C085	3	B	K061	2	B	R030	7	B	R084	6	B			

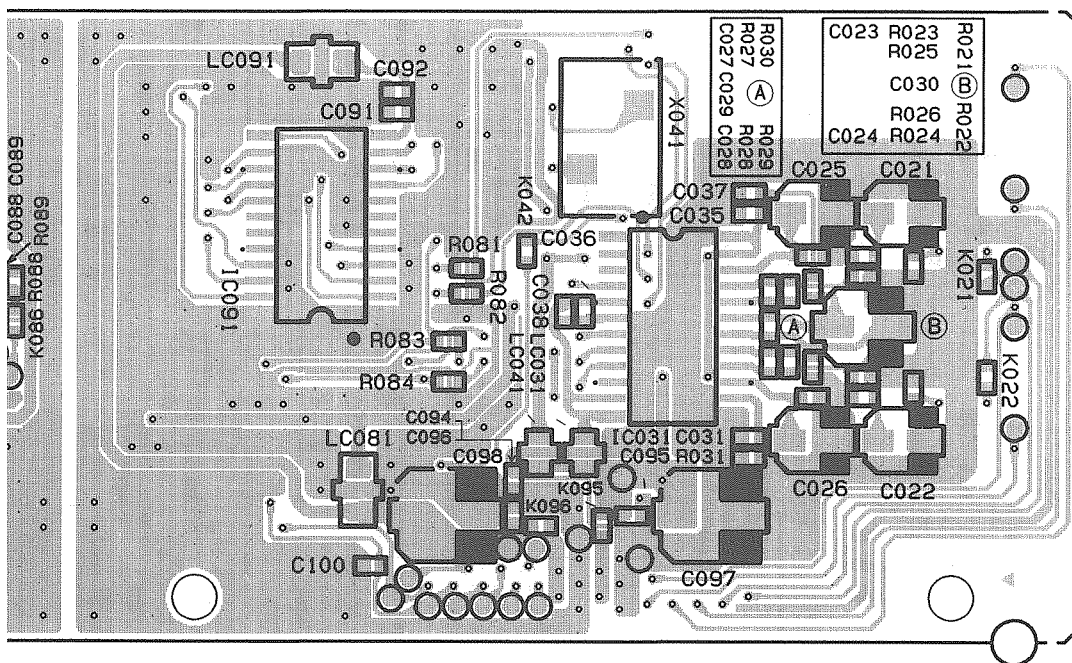

# Schematic Diagrams TUNER SECTION

FOR EF, EN, G, BS (WITH RDS)

ENA-178

□ FM 87.5MHz NO SIGNAL  
( ) MM522 KHz NO SIGNAL  
( ) LW 144KHz NO SIGNAL

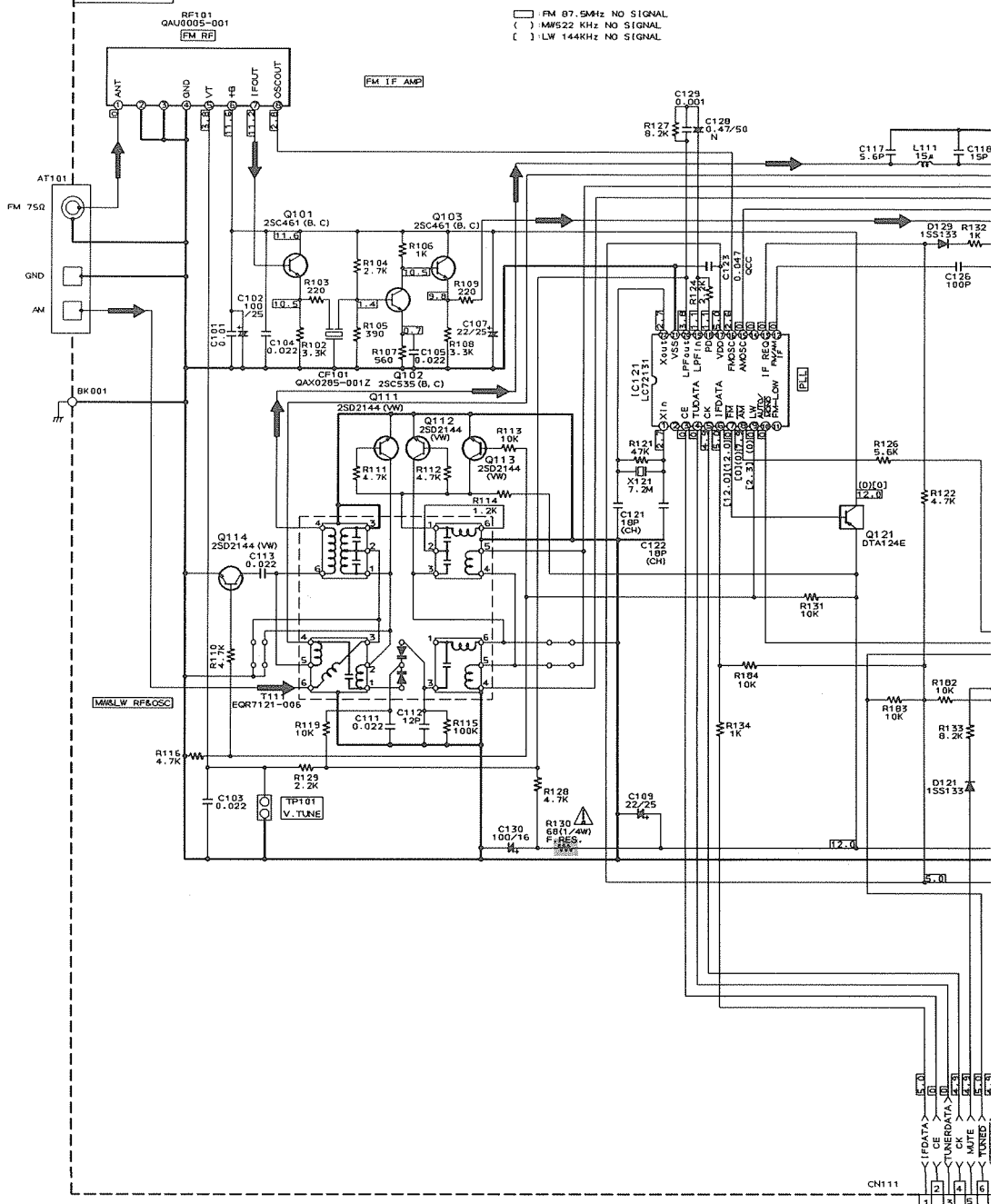

RE101  
QAU0005-001

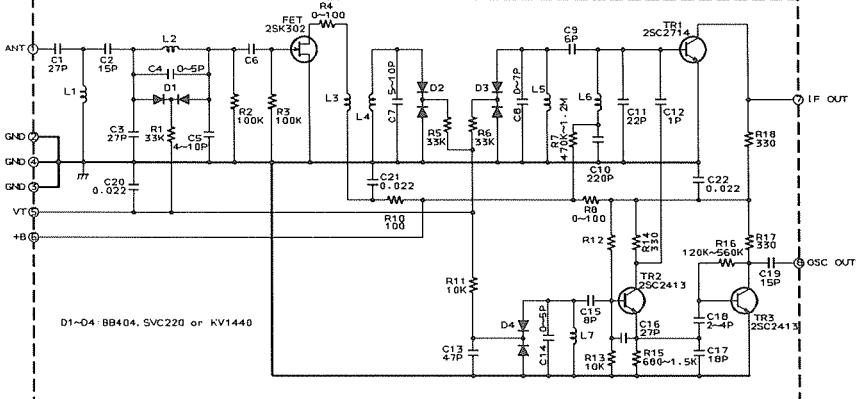

TO CN1  
ENC-  
(SHEE

J  
I  
H  
G  
F  
E  
D  
C  
B  
A

1 2 3 4 5



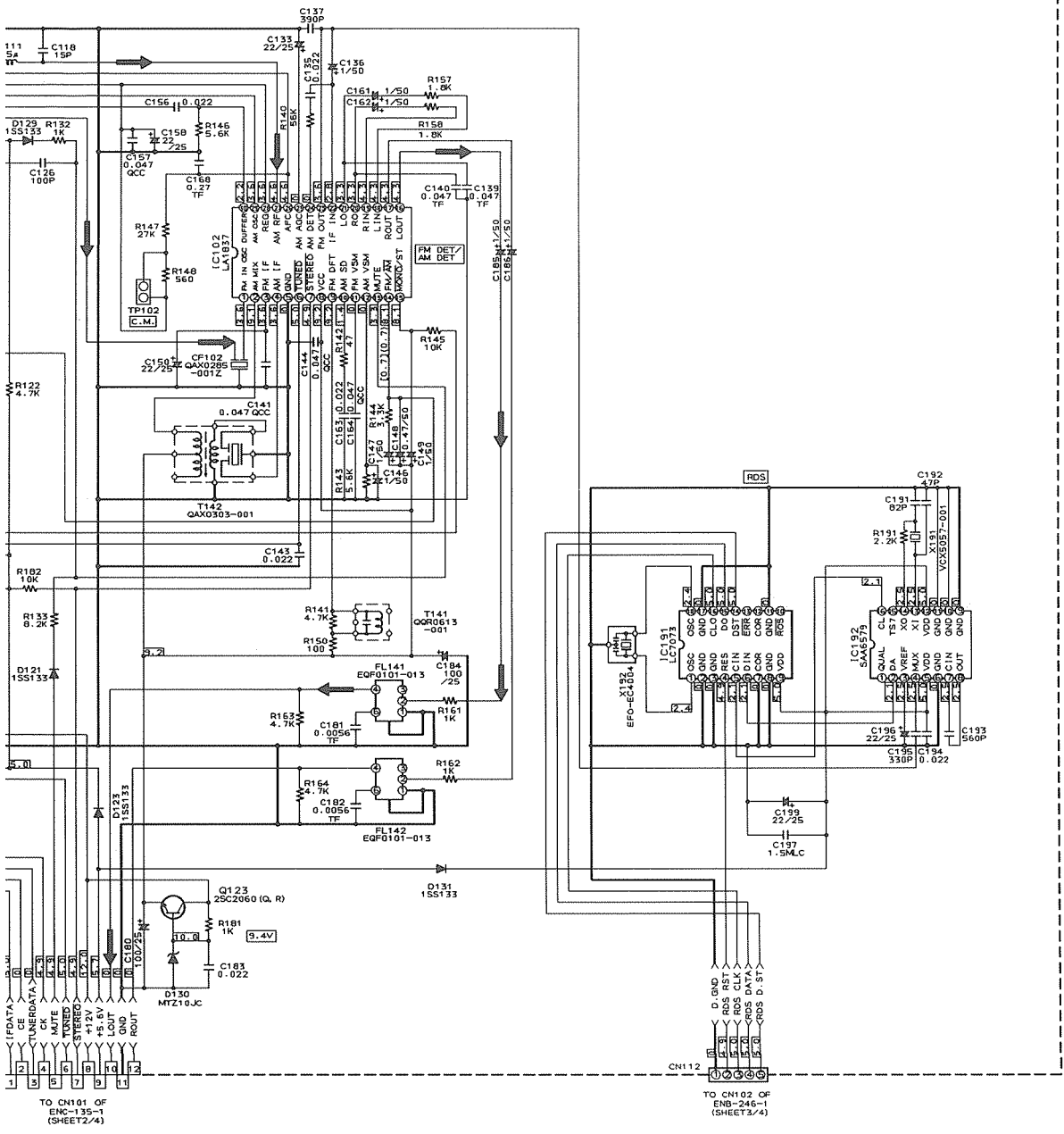

Notes:

1. indicates Main signal path.
2. indicates REAR signal path.
3. indicates CENTER signal path.
4. When replacing the parts in the darkened are ( ) and those marked with ,be sure to use the designated parts to ensure safety.
5. This is the standard circuit diagram.  
The design and contents are subject to change without notice.

3D PHONIC SECTION

J  
I  
H  
G  
F  
E  
D  
C  
B  
A

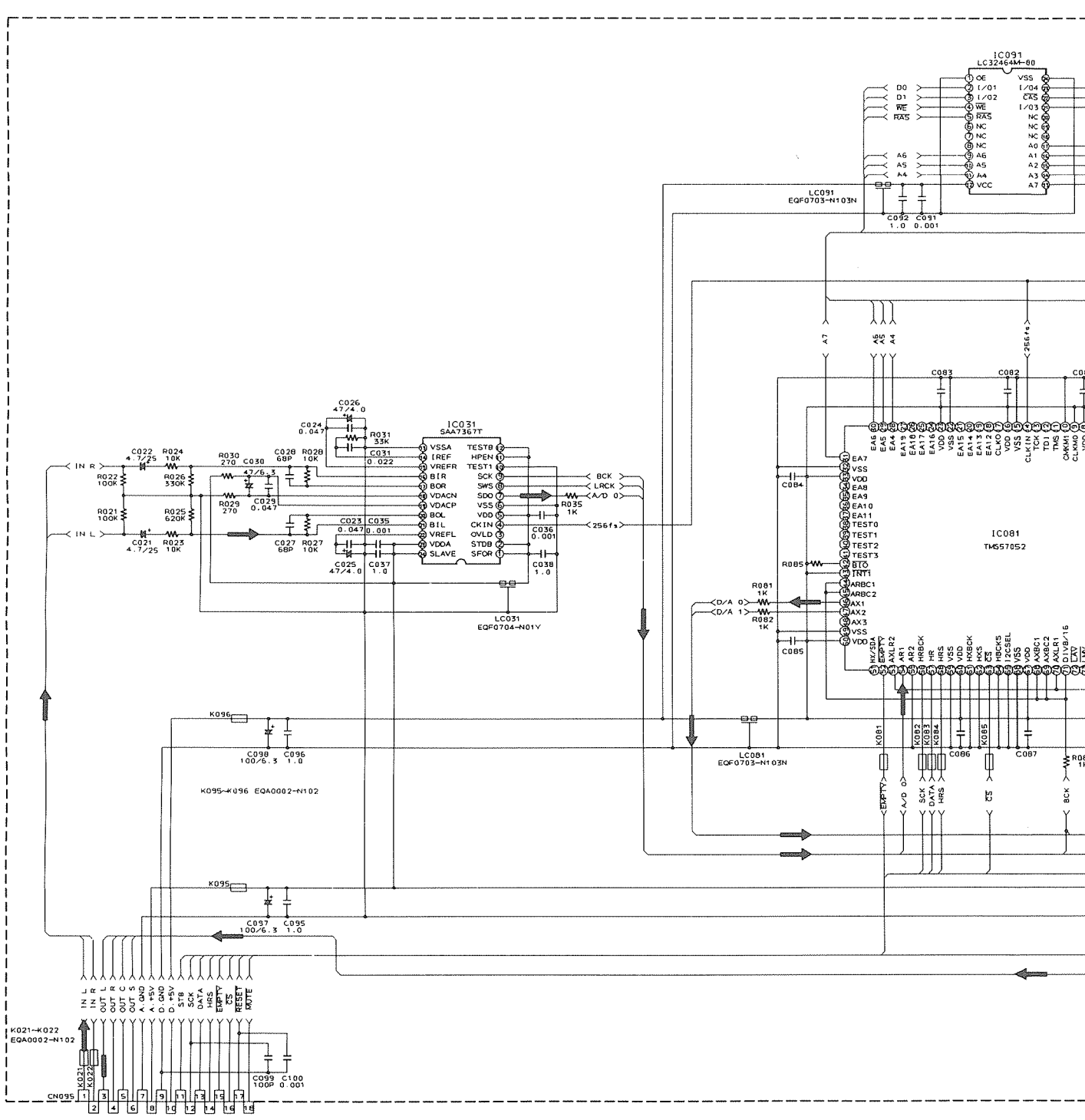

1 2 3 4 5

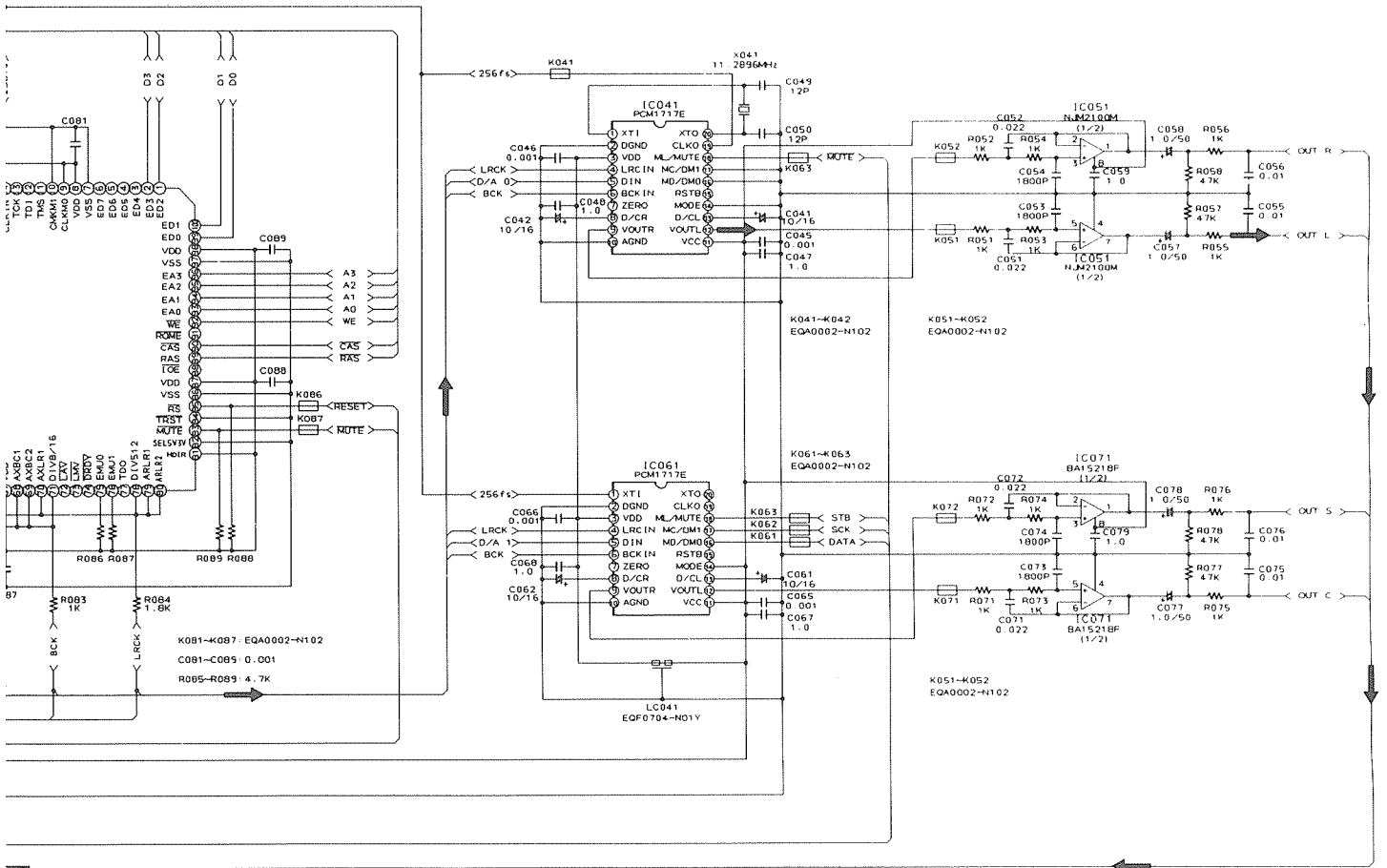
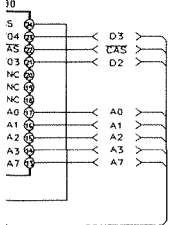

ENP-055



P2-33-a

P2-33-b

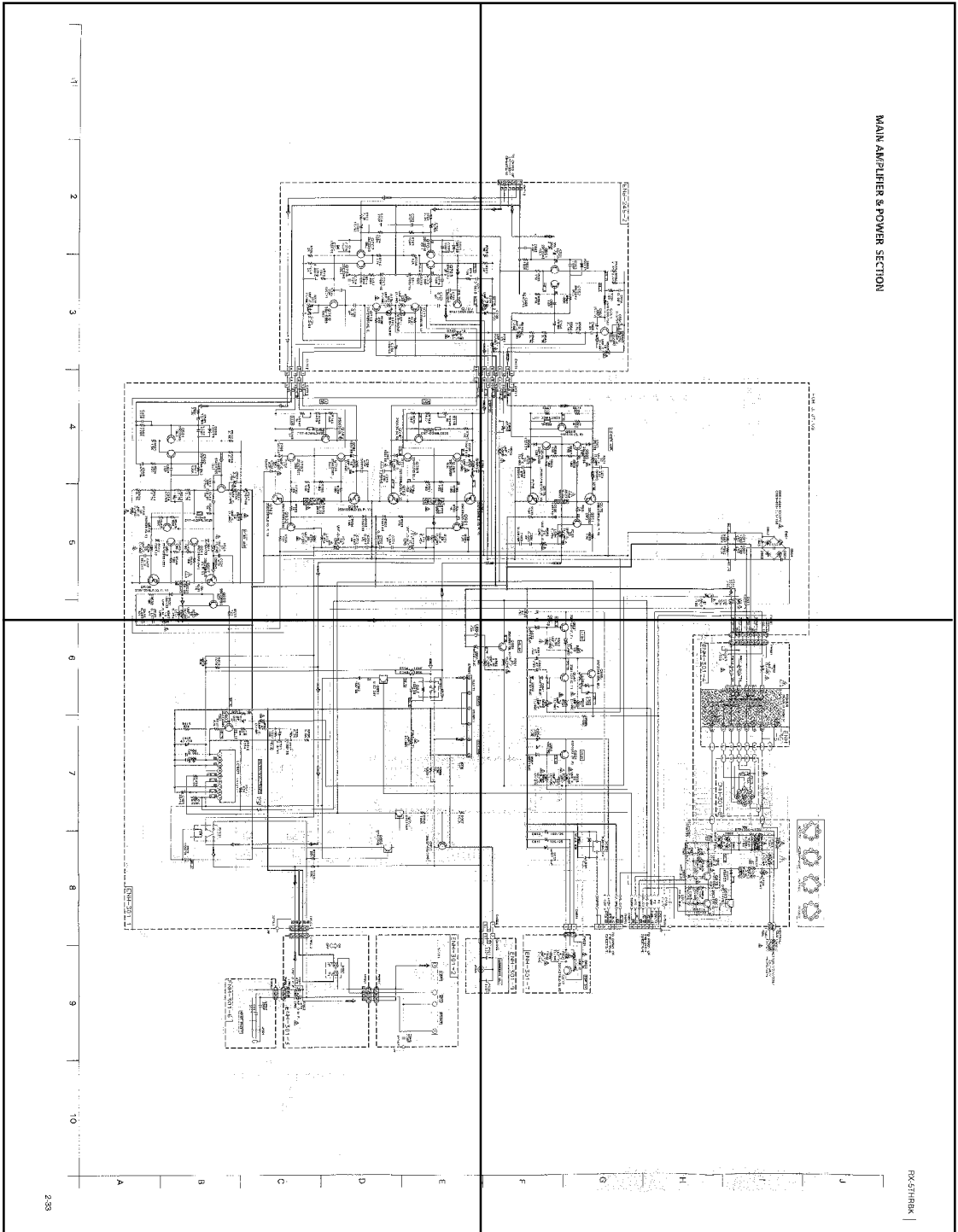

P2-33-c

P2-33-d

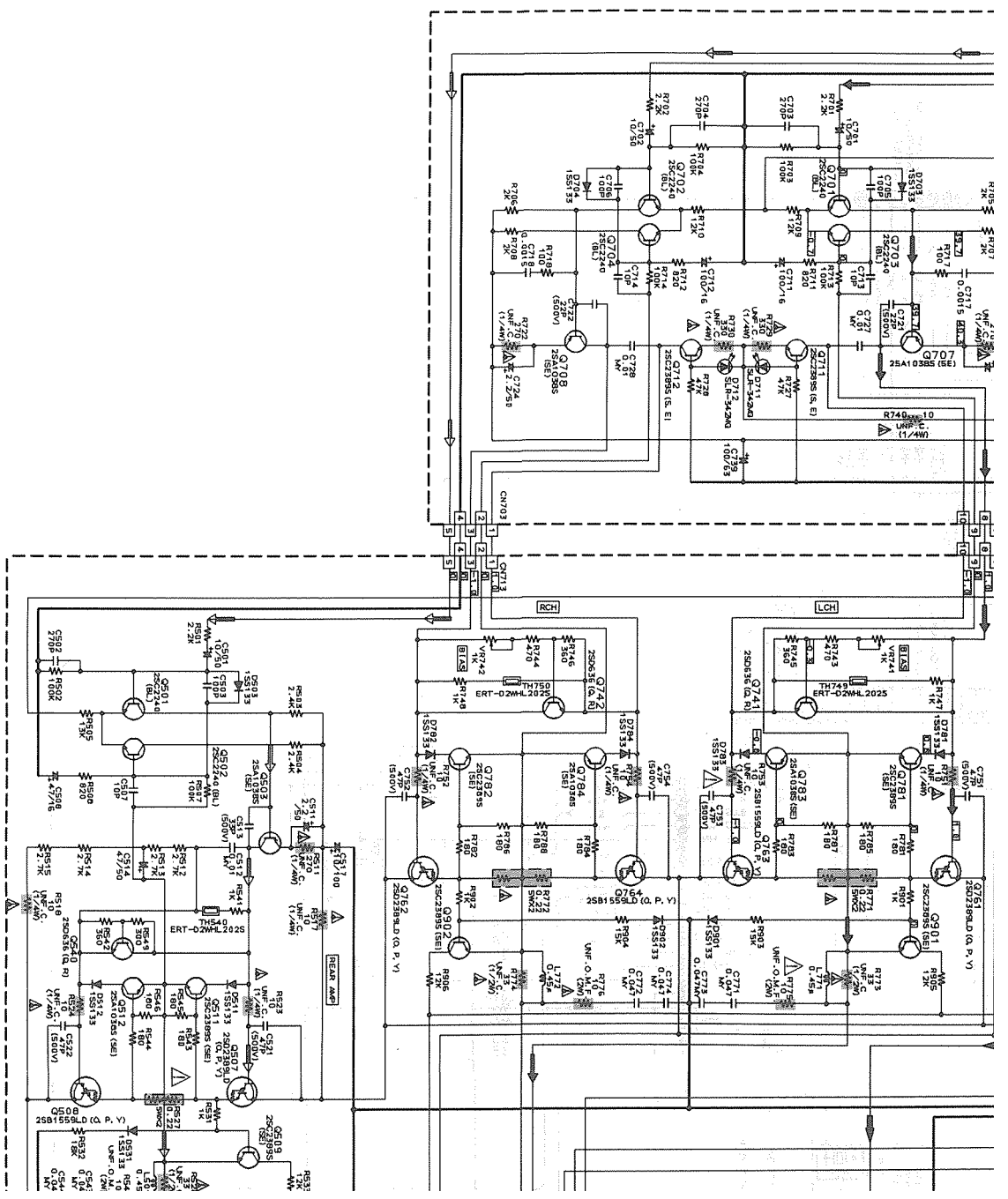

# MAIN AMPLIFIER & POWER SECTION

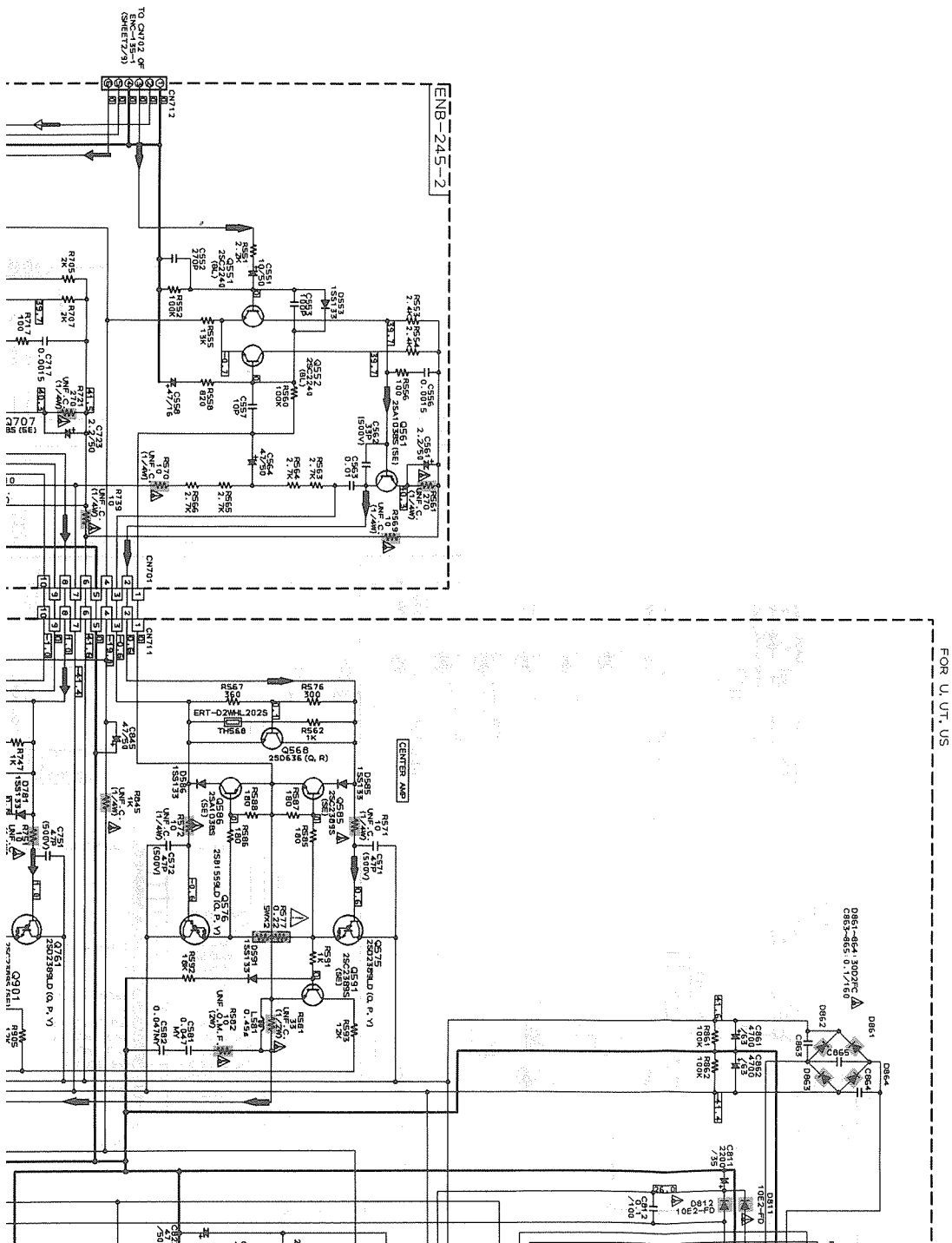

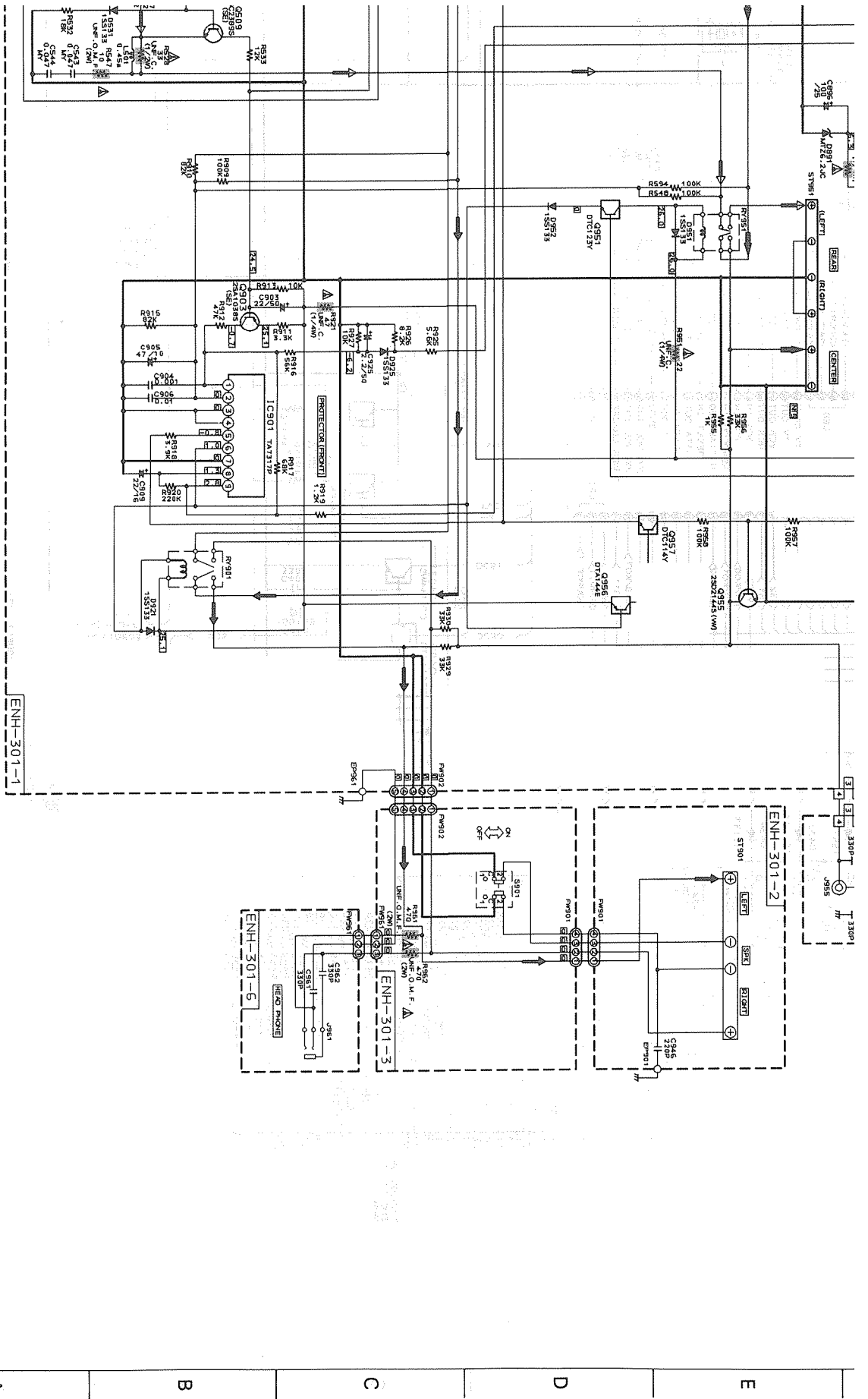

6  
7  
8  
9  
10

A  
B  
C  
D  
E



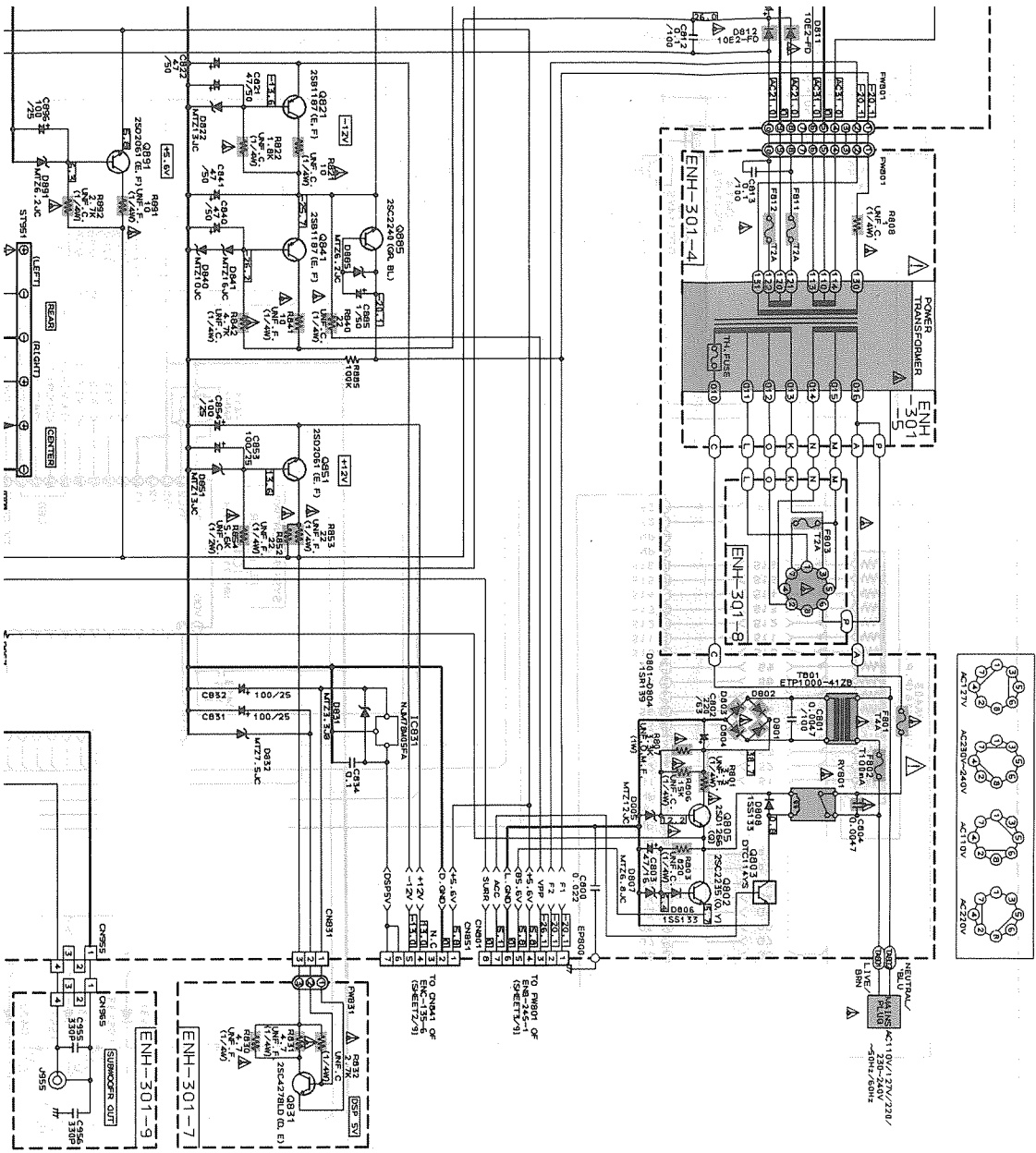

F G H I J



P2-34-a

P2-34-b

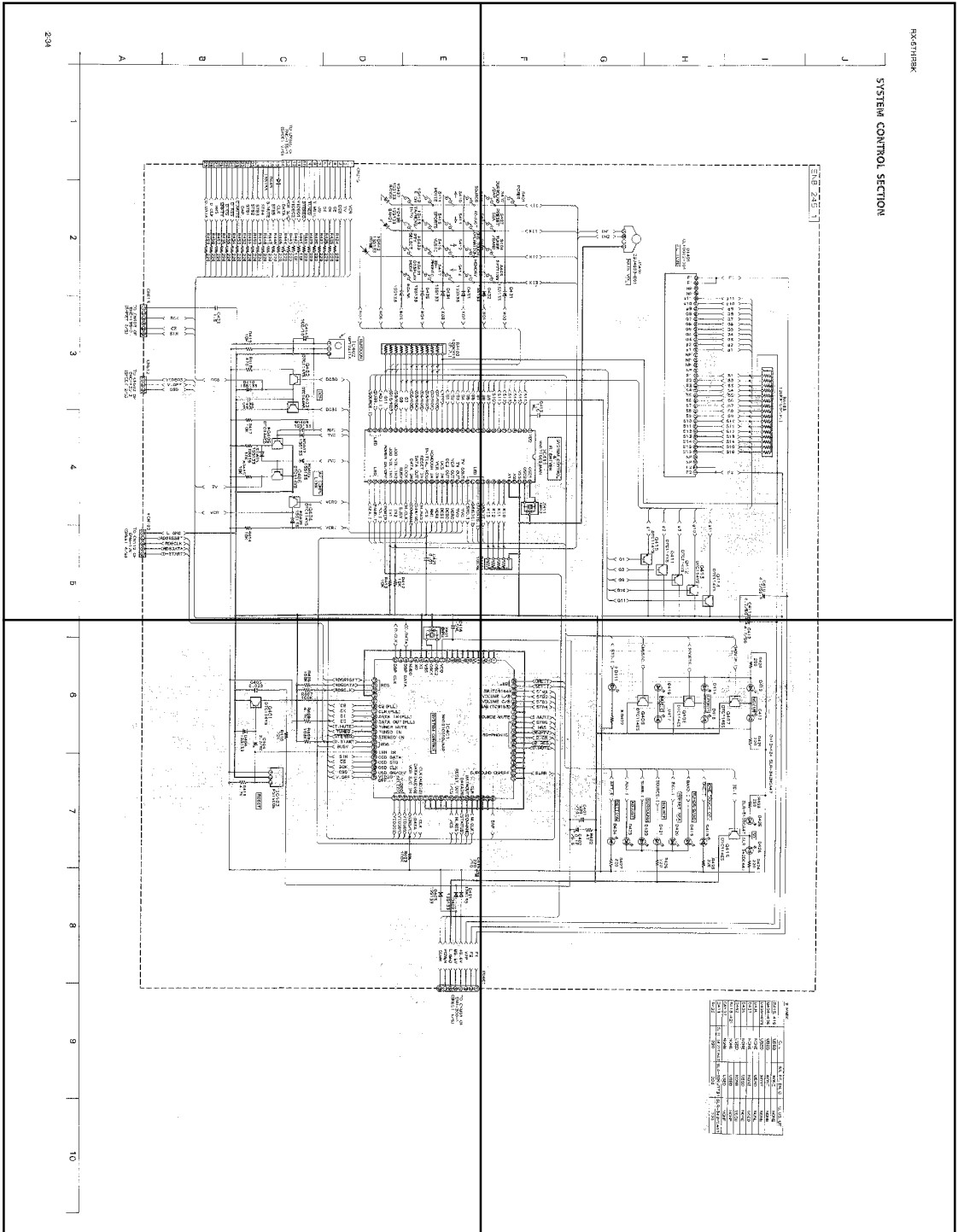

P2-34-c

P2-34-d

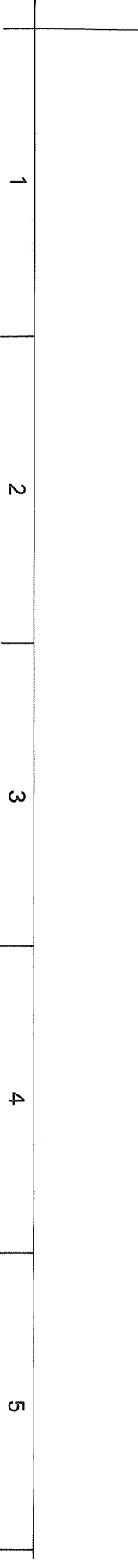
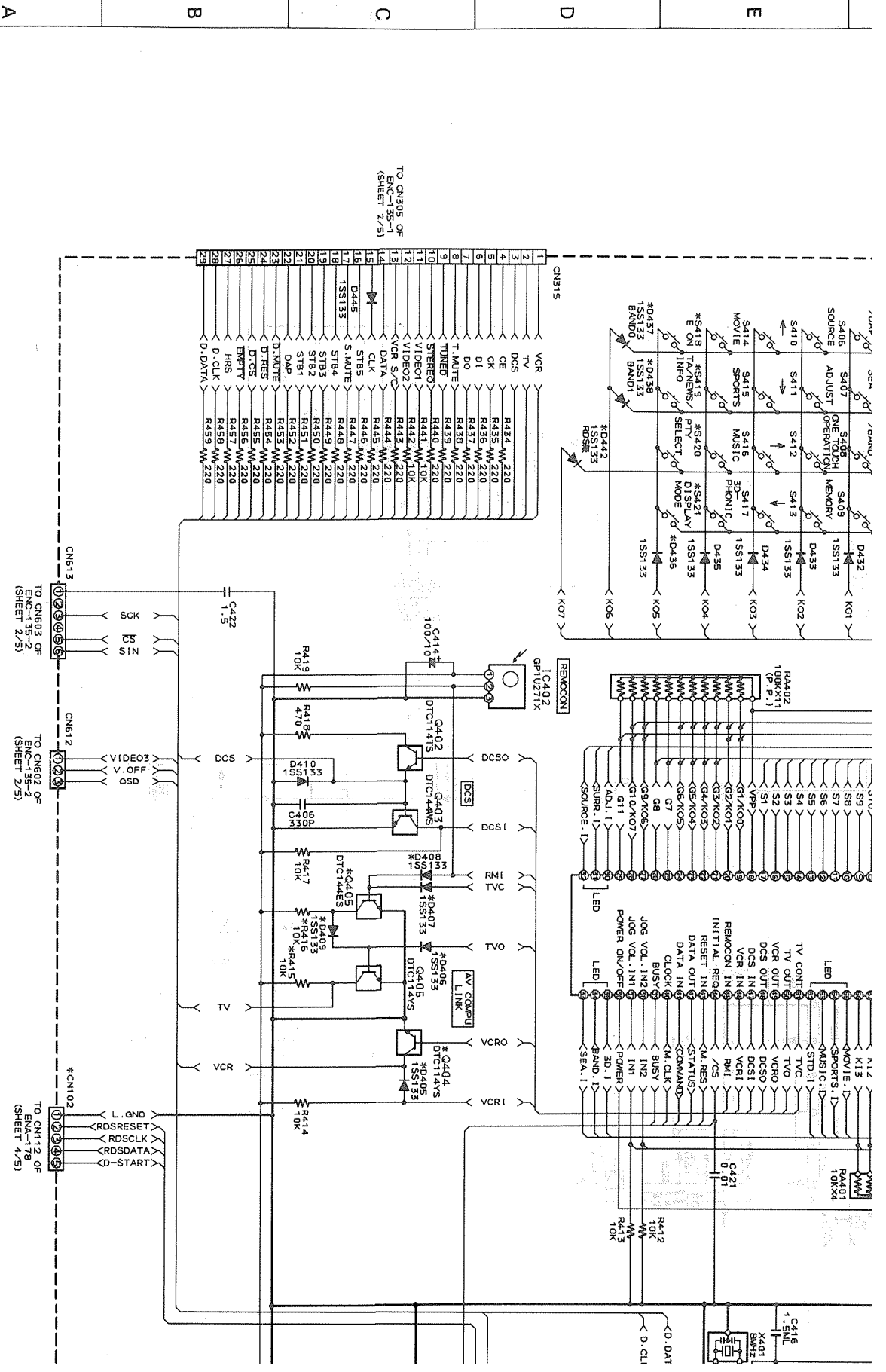

SYSTEM CONTROL SECTION

ENB-245-1

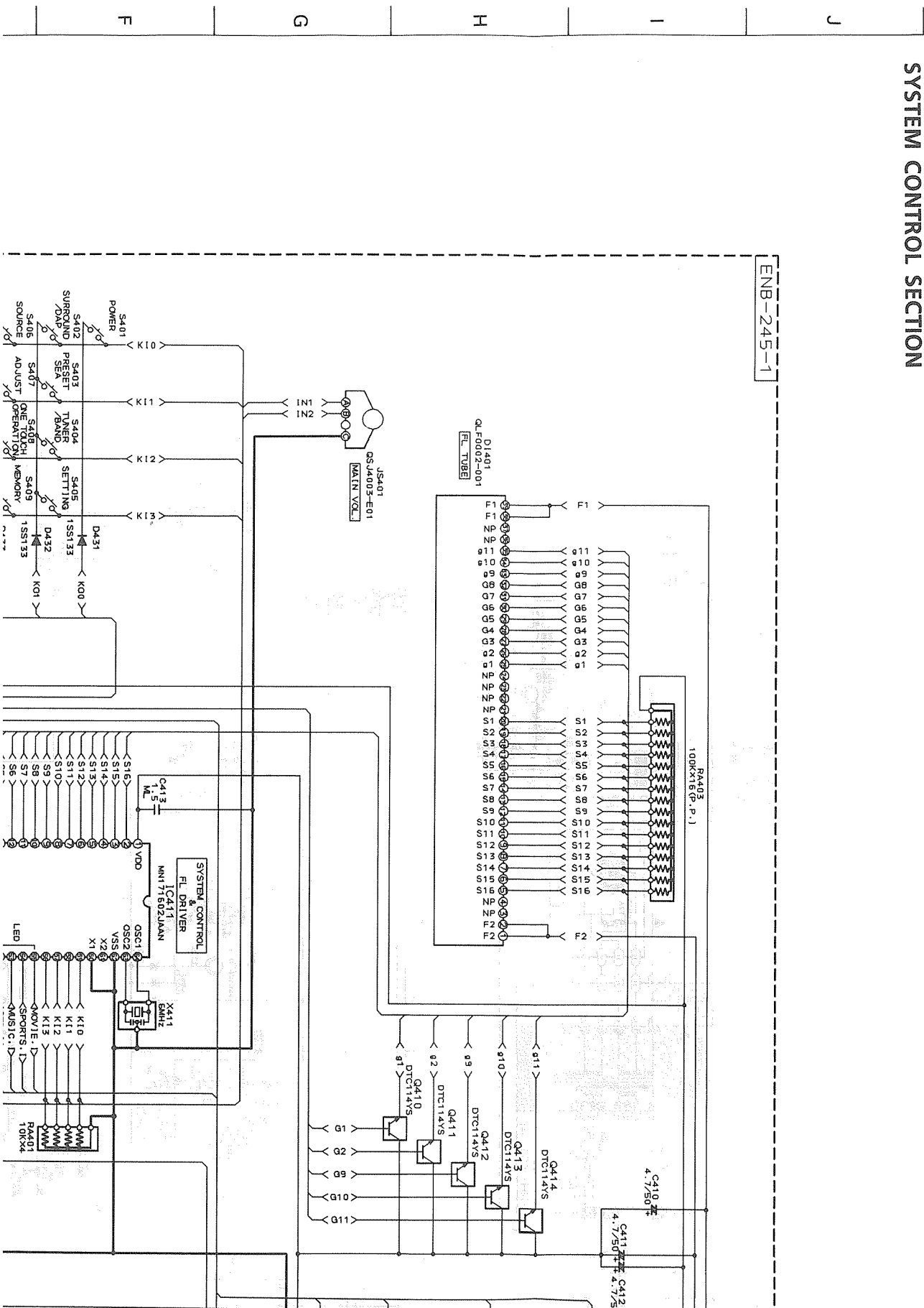

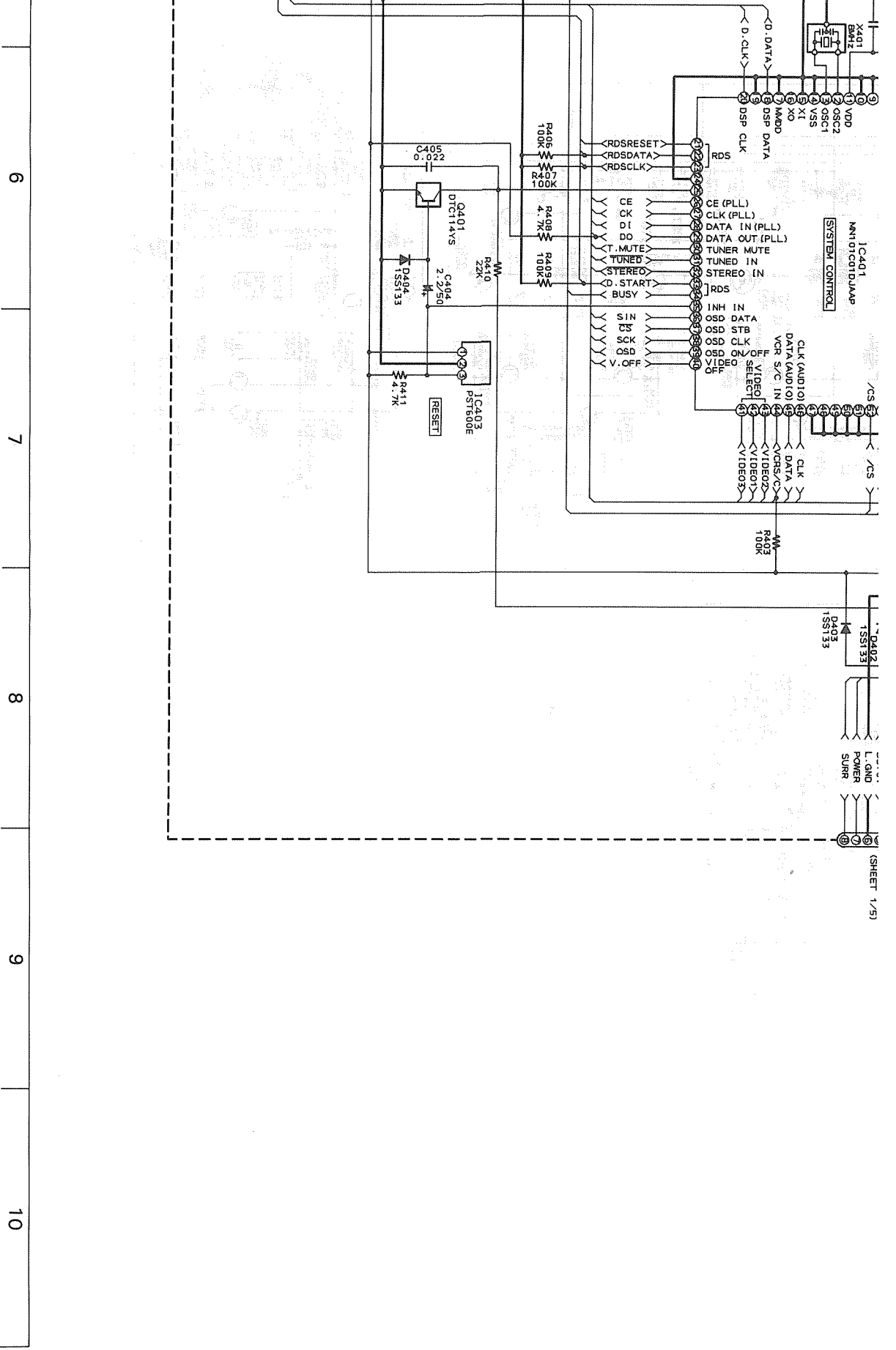

(SHEET 1/5)

6 7 8 9 10

	C. J	BS. FF. EN. G	U. US. UT
R415, 416	USED	NONE	NONE
Q404-406	USED	NONE	NONE
D405-409	USED	NONE	NONE
D436	NONE	USED	NONE
D437	NONE	NONE	USED
D438	NONE	USED	NONE
D442	USED	NONE	USED
S418-421	NONE	USED	NONE
CM102	NONE	USED	NONE
D411	SLR-342V/CA47	SLA-380J/T731	SLR-342V/CA47
R422	Z20	Z20	Z20

\* MARK

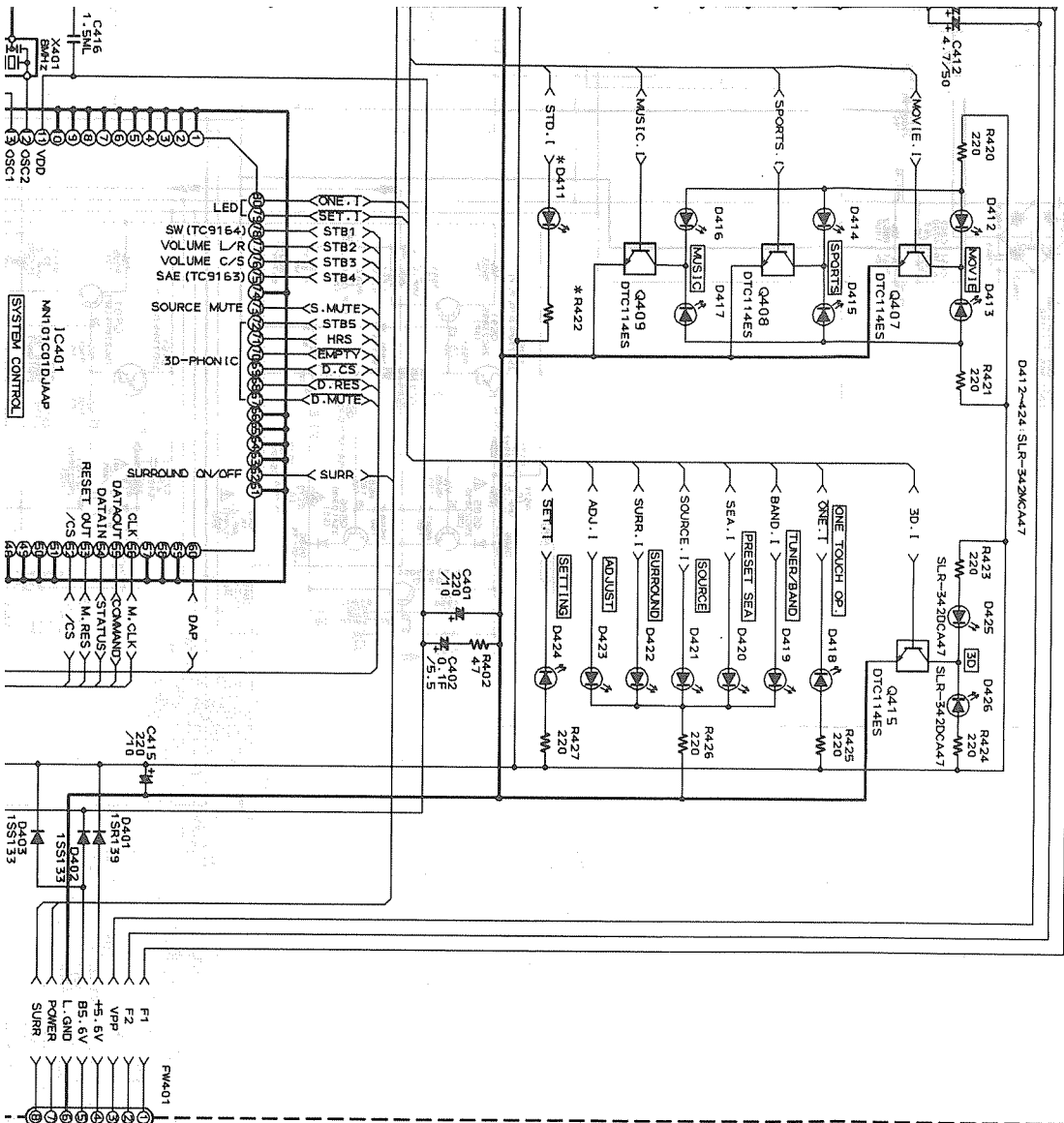

TO CNB01 OF  
EMH-300-1  
(SHEET 1/5)





P2-35-a

P2-35-b

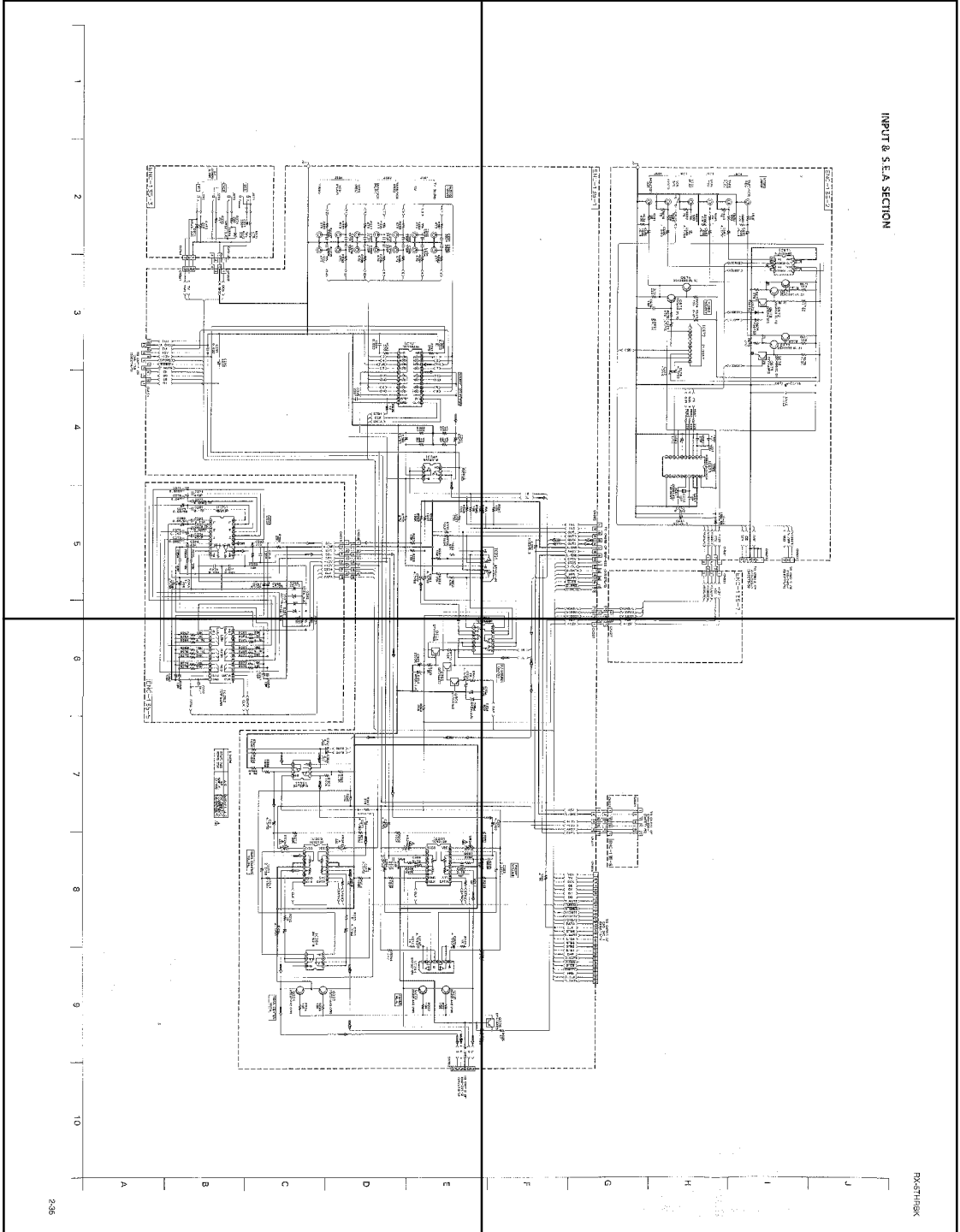

P2-35-c

P2-35-d

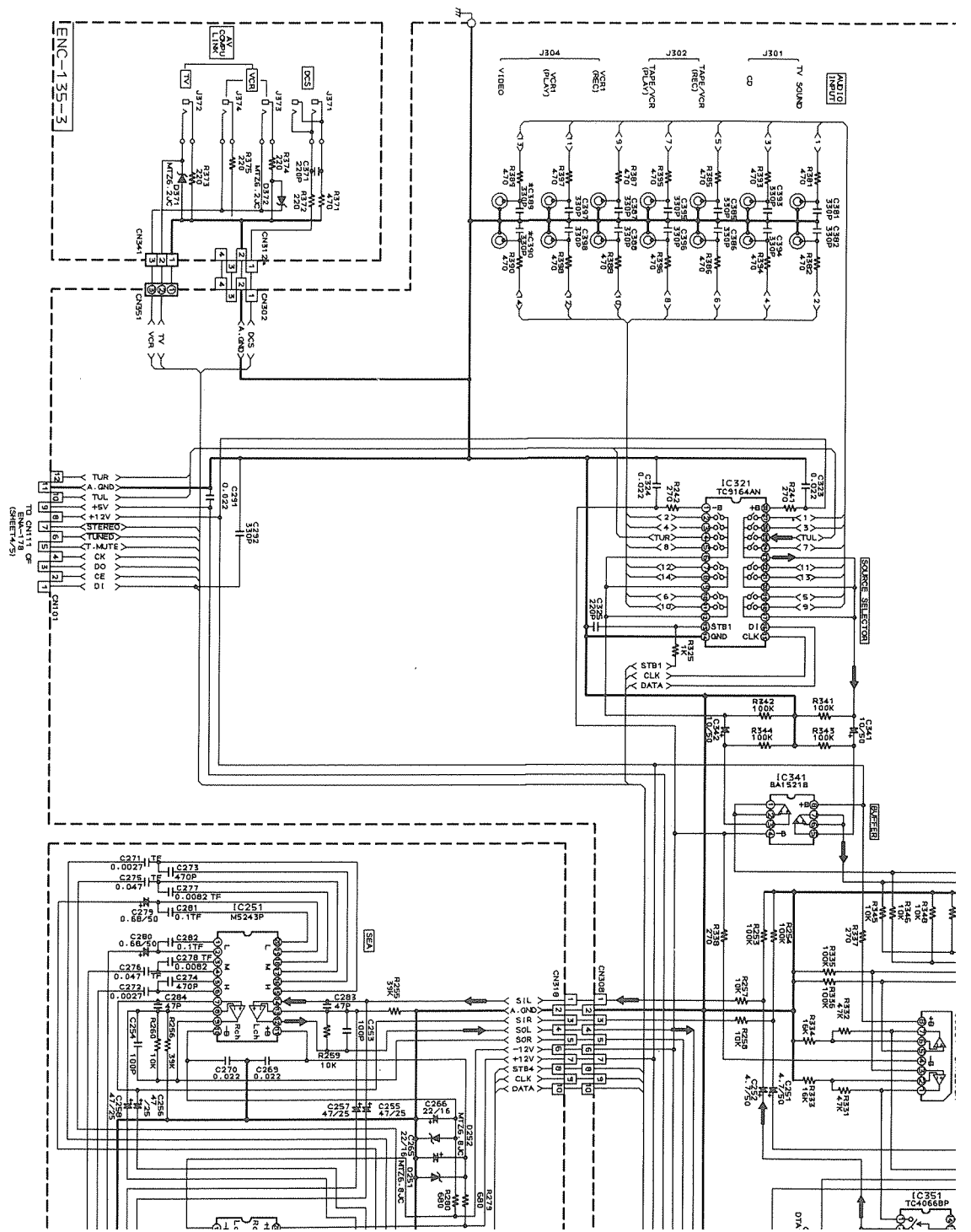

# INPUT & S.E.A SECTION

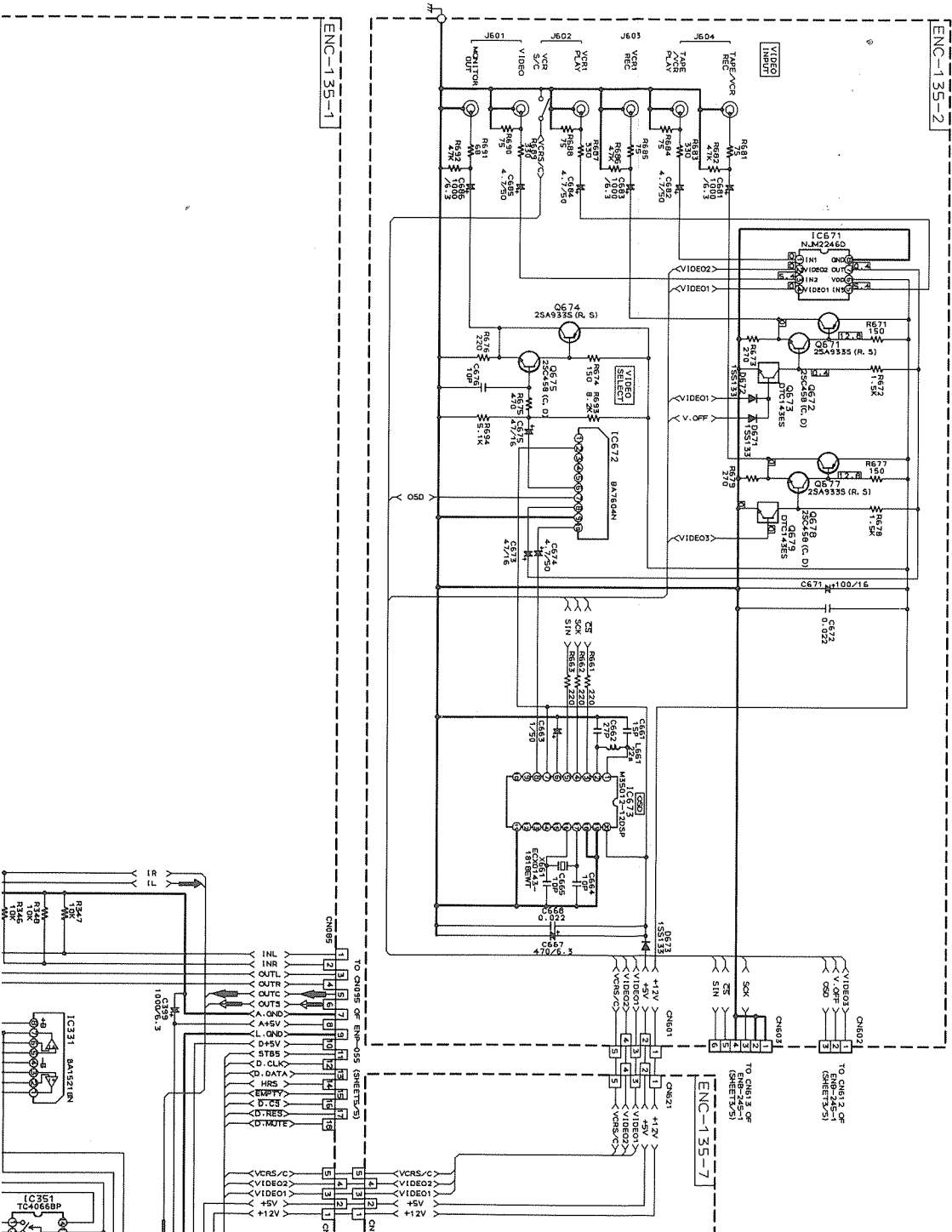

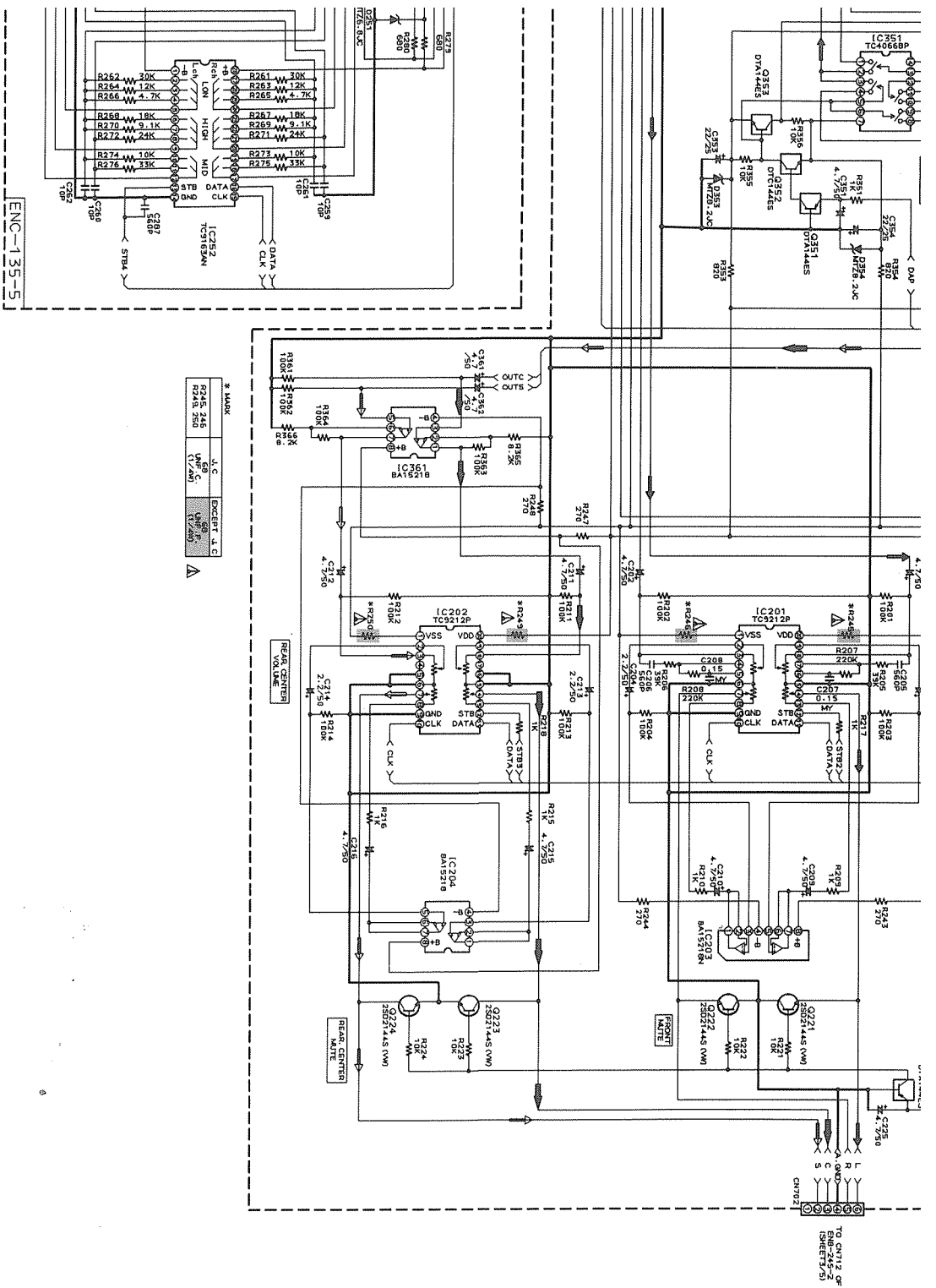

6 7 8 9 10

A B C D E

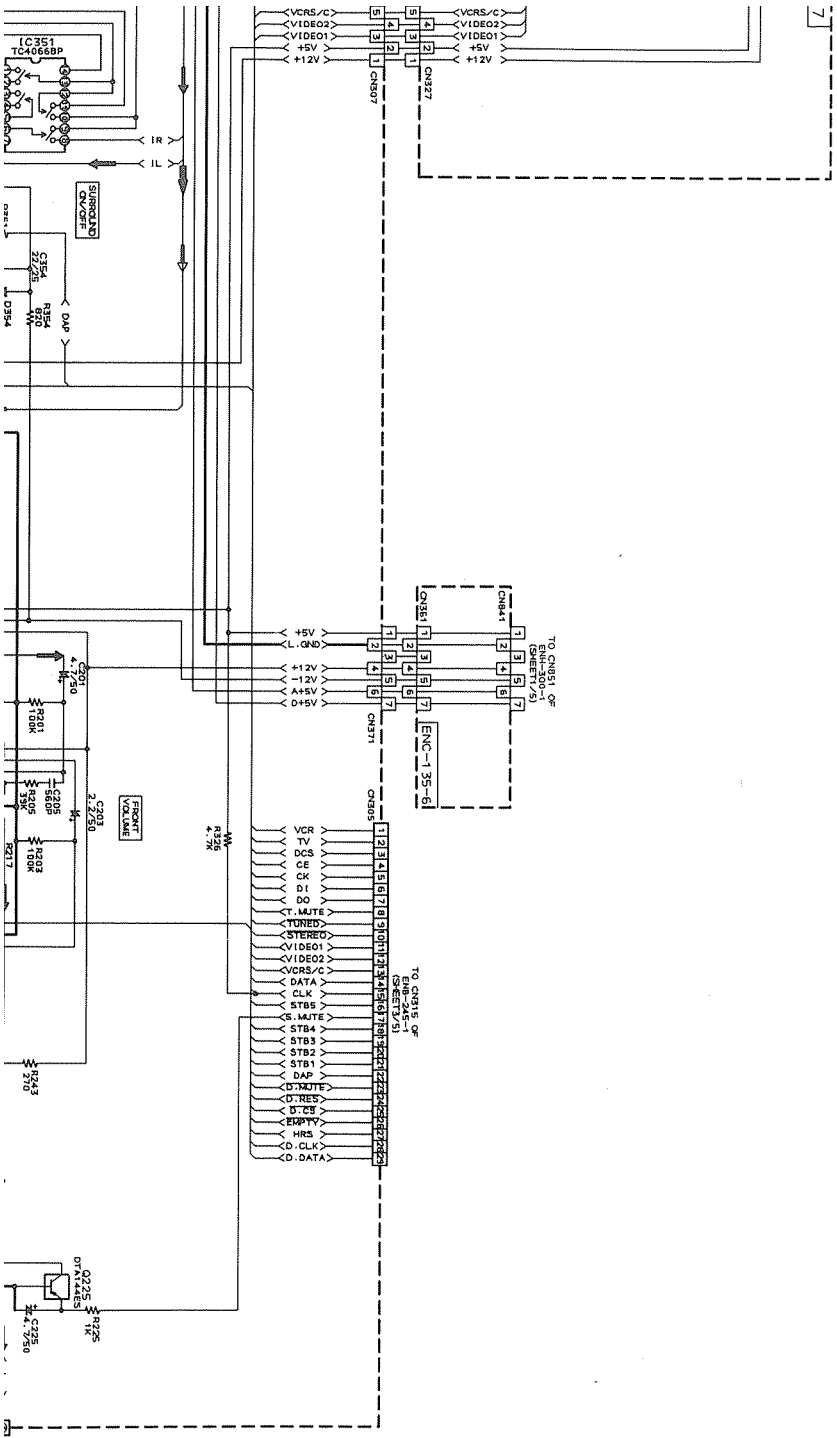



# PARTS LIST

\* All printed circuit boards and its assemblies are not available as service parts.

## The Marks for Designated Areas

EF	Continental Europe
EN	Scandinavia
G	Germany
Bs	the U. K.

## - Contents -

General Exploded View and Parts List .....	3-2
Electrical Parts List .....	3-4
(ENH-301) .....	3-4
(ENP-055) .....	3-6
(ENA-178) .....	3-7
(ENB-245) .....	3-8
(ENC-135) .....	3-10
Accessories List .....	3-12
Packing Materials and Part Numbers .....	3-13

## ■ Parts List

Symbol No.



△	Item	Parts Number	Parts Name	Q'ty	Description	Area
	1	EFP-RX5THRBKE (S	FRONT PANEL ASSY	1		
	1-1	E103255-007SM	FRONT PANEL	1		
	1-2	PQ45130-1-1	JVC MARK	1		
	2	E310167-002SM	PUSH BUTTON	1		
	3	FSJD4001-002	INDICATOR LENS	1		
	4	E209161-002SM	PUSH BUTTON	1	SOUND CONTROL	
	5	E310212-001SM	PUSH BUTTON	1	ONE TOUCH OPERATION	
	6	E209112-001SM	PUSH BUTTON	1		
	7	E209111-001SM	PUSH BUTTON	1		
	8	E310166-001SM	INDICATOR LENS	1		
	9	E209109-002SM	WINDOW SCREEN	1		
	10	E310174-001SM	KNOB RING	2		
	11	E406855-010	SPACER	4		
	12	SDSF2608Z	SCREW	9		
	13	SDSG3008M	TAPPING SCREW	9		
	14	SBSG3008CC	TAPPING SCREW	19		
	15	E103253-001SM	CHASSIS BASE	1		
	16	E209113-002SM	FRONT BRACKET	1		
	17	E68587-223SM	P. W. BOARD BRACKET	2		
	18	SBST3006CC	TAPPING SCREW	6		
	19	E47227-041SM	FOOT ASSY	2		
	20	SBST3010Z	TAPPING SCREW	2		
	21	E310170-001SM	PUSH BUTTON	2		
	22	VKZ4150-001	NUT	1		
	23	E309840-005SM	HEAT SINK	1		
	24	E310171-001SM	HEAT SINK BRACKET	1		
	25	E310172-001SM	HEAT SINK BRACKET	1		
	26	E73525-003	SCREW	9		
	27	2SD2390LD/OPY/	SI. TRANSISTOR	1	Q507	
		2SB1560LD/OPY/	SI. TRANSISTOR	1	Q508	
		2SD2390LD/OPY/	SI. TRANSISTOR	1	Q575	
		2SB1560LD/OPY/	SI. TRANSISTOR	1	Q576	
		2SD2390LD/OPY/	SI. TRANSISTOR	2	Q761, Q762	
		2SB1560LD/OPY/	SI. TRANSISTOR	2	Q763, Q764	
	28	LE40264-001A	PROTECTOR COVER	1		
	29	E310243-002	PLASTIC RIVET	3		
	30	QQT0164-003	POWER TRANSFORMER	1		
	31	E65389-006	SPECIAL SCREW	4		
	32	E406309-002	SPACER	4		
	33	E209114-010SM	REAR PANEL	1		
	34	E73273-006	SPECIAL SCREW	21		
	35	SBST3006M	TAPPING SCREW	2		
△	36	QMP39E0-200	POWER CORD	1		EF EN G
△	36	QMP5530-0085BS	POWER CORD	1		BS
△	37	QHS3771-108	CORD STOPPER	1		EF EN G
	38	E209116-004 (S)	METAL COVER	1		
	39	2SC4278LD (D, E)	SI. TRANSISTOR	1	Q831	
	40	E406308-003	SPECIAL SCREW	4		
	41	E310173-001SM	VOLUME KNOB	1		
△	42	QMF51E2-2R0	FUSE	1	F801	BS
△	43	QMF51A2-R10S	FUSE	1	F802	EN
△	44	QMF51E2-2R0	FUSE	2	F811, F812	BS
	45	E409530-001SM	C. B HOLDER	1		
	46	VWF1229-16TTB	FFC CABLE	1		
	47	E73967-010	SPACER	2		
	49	E306805-174	SPACER	1		
	50	E306805-092	SPACER	2		
	51	E310170-001SM	PUSH BUTTON	1	POWER	
	52	E310175-001SM	PUSH BUTTON	1	RDS	
	53	LE40217-201A	PROTECTOR COVER	1	POWER CORD	
	54	E307572-001	FASTENER	1		





# General Exploded View and Parts List

Block No. **MTMM**

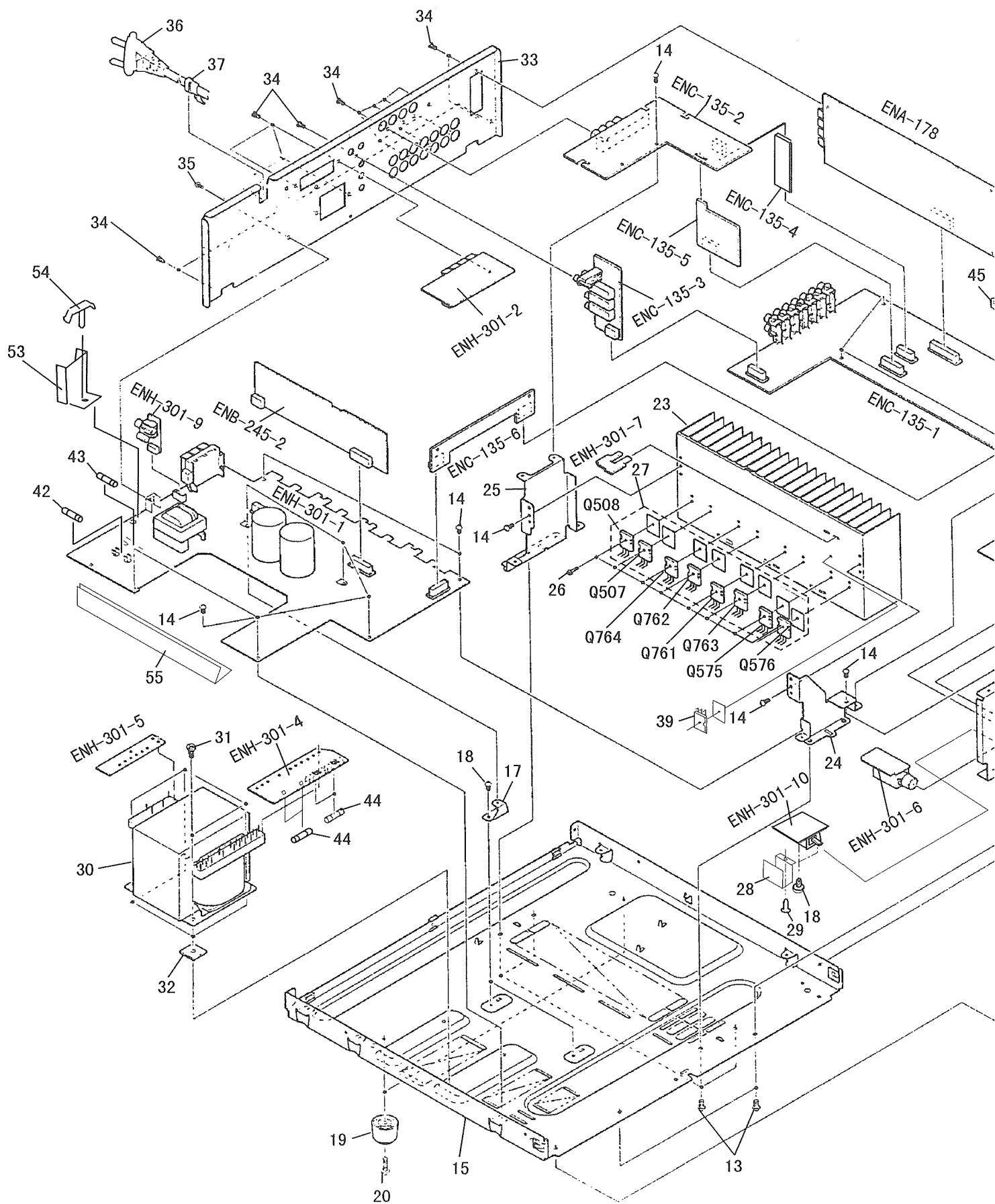

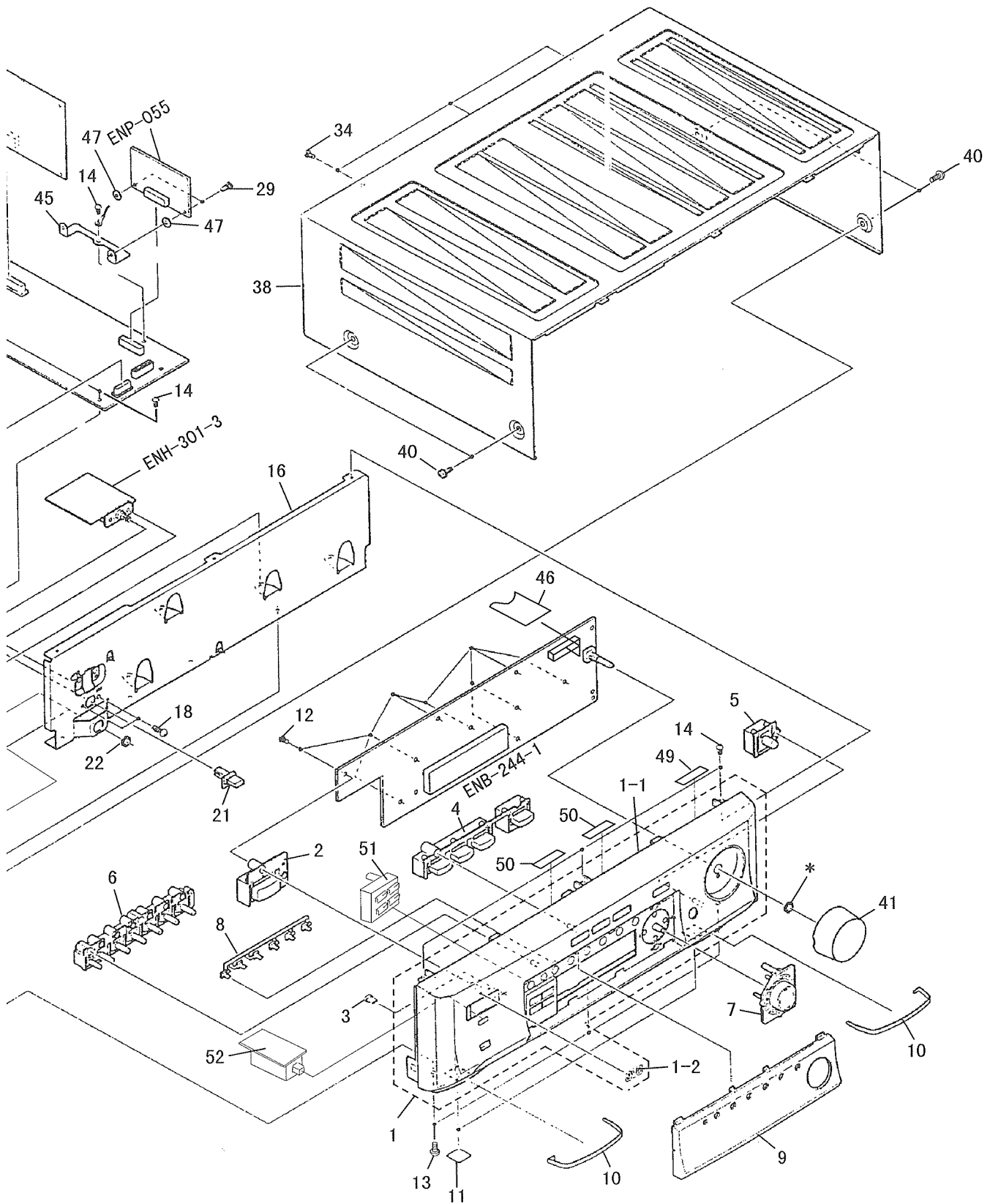

## ■ Electrical Parts List (ENH-301)

△	Item	Parts Number	Description	Area
		I. C. S		
	IC831	NJM78M05FA	I. C (MONO-ANALOG)	
	IC901	TA7317P	I. C (MONO-ANALOG)	
		DIODES		
	D503	1SS133	SI. DIODE	
	D511	1SS133	SI. DIODE	
	D512	1SS133	SI. DIODE	
	D531	1SS133	SI. DIODE	
	D585	1SS133	SI. DIODE	
	D586	1SS133	SI. DIODE	
	D591	1SS133	SI. DIODE	
	D781	1SS133	SI. DIODE	
	D782	1SS133	SI. DIODE	
	D783	1SS133	SI. DIODE	
	D784	1SS133	SI. DIODE	
	D801	1SR139-200	SI. DIODE	
	D802	1SR139-200	SI. DIODE	
	D803	1SR139-200	SI. DIODE	
	D804	1SR139-200	SI. DIODE	
	D806	1SS133	SI. DIODE	
	D807	MTZ6. 8JC	ZENER DIODE	
	D808	1SS133	SI. DIODE	
△	D811	10E2-FD	DIODE	
△	D812	10E2-FD	DIODE	
	D822	MTZ13JC	ZENER DIODE	
	D831	MTZ3. 3JB	ZENER DIODE	
	D832	MTZ7. 5JC	ZENER DIODE	
	D840	MTZ10JC	ZENER DIODE	
	D841	MTZ16JC	ZENER DIODE	
	D851	MTZ13JC	ZENER DIODE	
	D860	1SS133	SI. DIODE	
△	D861	30DF2SFC	SI. DIODE	
△	D862	30DF2SFC	SI. DIODE	
△	D863	30DF2SFC	SI. DIODE	
△	D864	30DF2SFC	SI. DIODE	
△	D865	30DF2SFC	SI. DIODE	
△	D866	30DF2SFC	SI. DIODE	
△	D867	30DF2SFC	SI. DIODE	
△	D868	30DF2SFC	SI. DIODE	
	D885	MTZ6. 2JC	ZENER DIODE	
	D891	MTZ6. 2JC	ZENER DIODE	
	D901	1SS133	SI. DIODE	
	D902	1SS133	SI. DIODE	
	D921	1SS133	SI. DIODE	
	D925	1SS133	SI. DIODE	
	D951	1SS133	SI. DIODE	
	D952	1SS133	SI. DIODE	
		TRANSISTORS		
	Q501	2SC2240 (BL)	SI. TRANSISTOR	
	Q502	2SC2240 (BL)	SI. TRANSISTOR	
	Q503	2SA1038 (R, S)	SI. TRANSISTOR	
	Q509	2SC2389 (S, E)	SI. TRANSISTOR	
	Q511	2SC2389 (S, E)	SI. TRANSISTOR	
	Q512	2SA1038 (R, S)	SI. TRANSISTOR	
	Q540	2SD636	SI. TRANSISTOR	
	Q568	2SD636	SI. TRANSISTOR	
	Q585	2SC2389 (S, E)	SI. TRANSISTOR	
	Q586	2SA1038 (R, S)	SI. TRANSISTOR	
	Q591	2SC2389 (S, E)	SI. TRANSISTOR	
	Q741	2SD636	SI. TRANSISTOR	
	Q742	2SD636	SI. TRANSISTOR	
	Q781	2SC2389 (S, E)	SI. TRANSISTOR	
	Q782	2SC2389 (S, E)	SI. TRANSISTOR	
	Q783	2SA1038 (R, S)	SI. TRANSISTOR	
	Q784	2SA1038 (R, S)	SI. TRANSISTOR	
	Q802	2SC2235 (O, Y)	SI. TRANSISTOR	
	Q803	DTC114ES	DIGITAL TRANSISTOR	
	Q821	2SB1187 (F, G)	SI. TRANSISTOR	
	Q841	2SB1187 (F, G)	SI. TRANSISTOR	
	Q851	2SD2061 (F, G)	SI. TRANSISTOR	
	Q860	DTC123YS	DIGITAL TRANSISTOR	
	Q885	2SC2240 (GR, BL)	SI. TRANSISTOR	
	Q891	2SD2061 (F, G)	SI. TRANSISTOR	

△	Item	Parts Number	Description	Area
	Q901	2SC2389 (S, E)	SI. TRANSISTOR	
	Q902	2SC2389 (S, E)	SI. TRANSISTOR	
	Q903	2SA1038 (R, S)	SI. TRANSISTOR	
	Q951	DTC123YS	DIGITAL TRANSISTOR	
	Q955	2SD2144S (VW)	SI. TRANSISTOR	
	Q956	DTA144ES	DIGITAL TRANSISTOR	
	Q957	DTC114YS	DIGITAL TRANSISTOR	
		CAPACITORS		
△	C001	QCZ9019-472	4700PF C. CAP.	
	C501	QETB1HM-106	10MF 50V E. CAP.	
	C502	QCS21HJ-271A	270PF 50V CER. CAP.	
	C503	QCS21HJ-101A	100PF 50V CER. CAP.	
	C507	QCS21HJ-100	10PF 50V CER. CAP.	
	C508	QETB1CM-476	47MF 16V AL E. CAP.	
	C511	QETB1HM-225	2.2MF 50V AL E. CAP.	
	C512	QFLB1HJ-103	0.01MF 50V MYLAR CAP.	
	C513	QCS22HJ-330	33PF 500V CER. CAP.	
	C514	QETB1HM-476	47MF 50V E. CAP.	
	C517	QETB2AM-106	10MF 100V AL E. CAP.	
	C521	QCS22HJ-470A	47PF 500V CER. CAP.	
	C522	QCS22HJ-470A	47PF 500V CER. CAP.	
	C543	QFLB1HJ-473	0.047MF 50V MYLAR CAP.	
	C544	QFLB1HJ-473	0.047MF 50V MYLAR CAP.	
	C571	QCS22HJ-470A	47PF 500V CER. CAP.	
	C572	QCS22HJ-470A	47PF 500V CER. CAP.	
	C581	QFLB1HJ-473	0.047MF 50V MYLAR CAP.	
	C582	QFLB1HJ-473	0.047MF 50V MYLAR CAP.	
	C751	QCS22HJ-470A	47PF 500V CER. CAP.	
	C752	QCS22HJ-470A	47PF 500V CER. CAP.	
	C753	QCS22HJ-470A	47PF 500V CER. CAP.	
	C754	QCS22HJ-470A	47PF 500V CER. CAP.	
	C771	QFLB1HJ-473	0.047MF 50V MYLAR CAP.	
	C772	QFLB1HJ-473	0.047MF 50V MYLAR CAP.	
	C773	QFLB1HJ-473	0.047MF 50V MYLAR CAP.	
	C774	QFLB1HJ-473	0.047MF 50V MYLAR CAP.	
	C800	QCHB1EZ-223	0.022MF 25V CER. CAP.	
	C801	QFN82AK-472	4700PF 100V METAL. MYLAR	
	C802	QETC1EM-227Z	220MF 25V AL E. CAP.	
	C803	QETB1CM-476	47MF 16V AL E. CAP.	
△	C804	QCZ9019-472	4700PF C. CAP.	
	C811	QETB1VM-228N	2200MF 35V E. CAP.	
	C812	QFN82AJ-104	0.1MF 100V MYLAR CAP.	
	C813	QFN82AJ-104	0.1MF 100V MYLAR CAP.	
	C816	QCF21HP-223A	0.022MF 50V CER. CAP.	
	C817	QCF21HP-223A	0.022MF 50V CER. CAP.	
	C820	QCB1HK-471Y	470PF 50V CER. CAP.	
	C821	QETB1HM-476	47MF 50V E. CAP.	
	C822	QETB1HM-476	47MF 50V E. CAP.	
	C831	QETB1EM-107	100MF 25V AL E. CAP.	
	C832	QETB1EM-107	100MF 25V AL E. CAP.	
	C834	QFLB1HJ-104	0.1MF 50V MYLAR CAP.	
	C840	QETB1HM-476	47MF 50V E. CAP.	
	C841	QETB1HM-476	47MF 50V E. CAP.	
	C845	QETB1HM-476	47MF 50V E. CAP.	
	C853	QETB1EM-107	100MF 25V AL E. CAP.	
	C854	QETB1EM-107	100MF 25V AL E. CAP.	
	C861	QE20225-478	4700MF E. CAP.	
	C862	QE20225-478	4700MF E. CAP.	
	C863	QFN82CK-104	0.1MF 160V METAL. MYLAR	
	C864	QFN82CK-104	0.1MF 160V METAL. MYLAR	
	C865	QFN82CK-104	0.1MF 160V METAL. MYLAR	
	C866	QFN82CK-104	0.1MF 160V METAL. MYLAR	
	C867	QFN82CK-104	0.1MF 160V METAL. MYLAR	
	C868	QFN82CK-104	0.1MF 160V METAL. MYLAR	
	C869	QFN82AJ-104	0.1MF 100V MYLAR CAP.	
	C885	QETB1HM-105	1MF 50V AL E. CAP.	
	C896	QETB1EM-107	100MF 25V AL E. CAP.	
	C903	QETB1HM-226E	22MF 50V E. CAP.	
	C904	QCY31HK-102Z	1000PF 50V CER. CAP.	
	C905	QETB1AM-476	47MF 10V E. CAP.	
	C906	QCF21HP-103A	0.01MF 50V CER. CAP.	
	C909	QETB1CM-226	22MF 16V E. CAP.	
	C925	QETB1HM-225	2.2MF 50V AL E. CAP.	

■ Electrical Parts List (ENH-301)

△	Item	Parts Number	Description	Area
	C931	QFLB1HJ-223	0.022MF 50V MYLAR CAP.	
	C932	QFLB1HJ-223	0.022MF 50V MYLAR CAP.	
	C935	QCS21HJ-221	220PF 50V CER. CAP.	
	C936	QCS21HJ-221	220PF 50V CER. CAP.	
	C941	QCS21HJ-221	220PF 50V CER. CAP.	
	C942	QCS21HJ-221	220PF 50V CER. CAP.	
	C945	QCS21HJ-221	220PF 50V CER. CAP.	
	C946	QCS21HJ-221	220PF 50V CER. CAP.	
	C955	QCB1HK-331Y	330PF 50V CER. CAP.	
	C956	QCB1HK-331Y	330PF 50V CER. CAP.	
	C961	QCB1HK-331Y	330PF 50V CER. CAP.	
	C962	QCB1HK-331Y	330PF 50V CER. CAP.	
	C971	QFLB1HJ-223	0.022MF 50V MYLAR CAP.	
	C972	QCS21HJ-221	220PF 50V CER. CAP.	
	C973	QCS21HJ-221	220PF 50V CER. CAP.	
	C974	QCS21HJ-221	220PF 50V CER. CAP.	
	C981	QFLB1HJ-223	0.022MF 50V MYLAR CAP.	
	C982	QFLB1HJ-223	0.022MF 50V MYLAR CAP.	
	C983	QCS21HJ-221	220PF 50V CER. CAP.	
	C984	QCS21HJ-221	220PF 50V CER. CAP.	
	C985	QCS21HJ-221	220PF 50V CER. CAP.	
	C986	QCS21HJ-221	220PF 50V CER. CAP.	
	C987	QCS21HJ-221	220PF 50V CER. CAP.	
		RESISTORS		
	R501	QRD161J-222	2.2K 1/6W CARBON RES.	
	R502	QRD161J-104	100K 1/6W CARBON RES.	
	R503	QRD161J-202	2K 1/6W CARBON RES.	
	R503	QRD161J-222	2.2K 1/6W CARBON RES.	
	R504	QRD161J-202	2K 1/6W CARBON RES.	
	R504	QRD161J-222	2.2K 1/6W CARBON RES.	
	R505	QRD161J-123	12K 1/6W CARBON RES.	
	R505	QRD161J-133Y	13K 1/6W CARBON RES.	
	R507	QRD161J-104	100K 1/6W CARBON RES.	
	R508	QRD161J-102	1K 1/6W CARBON RES.	
△	R511	QRD14CJ-181S	180 1/4W UNF. CARBON R	
△	R511	QRD14CJ-271S	270 1/4W UNF. CARBON R	
	R512	QRD167J-272	2.7K 1/6W CARBON RES.	
	R513	QRD167J-272	2.7K 1/6W CARBON RES.	
	R514	QRD167J-272	2.7K 1/6W CARBON RES.	
	R515	QRD167J-272	2.7K 1/6W CARBON RES.	
△	R517	QRD14CJ-100SX	10 1/4W UNF. CARBON R	
△	R518	QRD14CJ-100SX	10 1/4W UNF. CARBON R	
△	R523	QRD14CJ-100SX	10 1/4W UNF. CARBON R	
△	R524	QRD14CJ-100SX	10 1/4W UNF. CARBON R	
	R527	QRZ0195-R22	0.22 1W FUSIBLE RES.	
△	R528	QRD125J-330	33 1/2W UNF. CARBON R	
	R531	QRD161J-102	1K 1/6W CARBON RES.	
	R532	QRD161J-183	18K 1/6W CARBON RES.	
	R533	QRD161J-123	12K 1/6W CARBON RES.	
	R541	QRD161J-102	1K 1/6W CARBON RES.	
	R542	QRD161J-361	360 1/6W CARBON RES.	
	R543	QRD161J-181	180 1/6W CARBON RES.	
	R544	QRD161J-181	180 1/6W CARBON RES.	
	R545	QRD161J-181	180 1/6W CARBON RES.	
	R546	QRD161J-181	180 1/6W CARBON RES.	
△	R547	QRG022J-100A	10 2W OXIDE METAL	
	R548	QRD161J-104	100K 1/6W CARBON RES.	
	R549	QRD161J-301	300 1/6W CARBON RES.	
	R562	QRD161J-102	1K 1/6W CARBON RES.	
	R567	QRD161J-361	360 1/6W CARBON RES.	
△	R571	QRD14CJ-100SX	10 1/4W UNF. CARBON R	
△	R572	QRD14CJ-100SX	10 1/4W UNF. CARBON R	
	R576	QRD161J-301	300 1/6W CARBON RES.	
	R577	QRZ0195-R22	0.22 1W FUSIBLE RES.	
△	R581	QRD125J-330	33 1/2W UNF. CARBON R	
△	R582	QRG022J-100A	10 2W OXIDE METAL	
	R585	QRD161J-181	180 1/6W CARBON RES.	
	R586	QRD161J-181	180 1/6W CARBON RES.	
	R587	QRD161J-181	180 1/6W CARBON RES.	
	R588	QRD161J-181	180 1/6W CARBON RES.	
	R591	QRD161J-102	1K 1/6W CARBON RES.	
	R592	QRD161J-183	18K 1/6W CARBON RES.	
	R593	QRD161J-123	12K 1/6W CARBON RES.	

△	Item	Parts Number	Description	Area
	R594	QRD161J-104	100K 1/6W CARBON RES.	
	R743	QRD161J-471	470 1/6W CARBON RES.	
	R744	QRD161J-471	470 1/6W CARBON RES.	
	R745	QRD161J-361	360 1/6W CARBON RES.	
	R746	QRD161J-361	360 1/6W CARBON RES.	
	R747	QRD161J-102	1K 1/6W CARBON RES.	
	R748	QRD161J-102	1K 1/6W CARBON RES.	
△	R751	QRD14CJ-100SX	10 1/4W UNF. CARBON R	
△	R752	QRD14CJ-100SX	10 1/4W UNF. CARBON R	
△	R753	QRD14CJ-100SX	10 1/4W UNF. CARBON R	
△	R754	QRD14CJ-100SX	10 1/4W UNF. CARBON R	
	R771	QRZ0195-R22	0.22 1W FUSIBLE RES.	
	R772	QRZ0195-R22	0.22 1W FUSIBLE RES.	
△	R773	QRD125J-330	33 1/2W UNF. CARBON R	
△	R774	QRD125J-330	33 1/2W UNF. CARBON R	
△	R775	QRG022J-100A	10 2W OXIDE METAL	
△	R776	QRG022J-100A	10 2W OXIDE METAL	
	R781	QRD161J-181	180 1/6W CARBON RES.	
	R782	QRD161J-181	180 1/6W CARBON RES.	
	R783	QRD161J-181	180 1/6W CARBON RES.	
	R784	QRD161J-181	180 1/6W CARBON RES.	
	R785	QRD161J-181	180 1/6W CARBON RES.	
	R785	QRD167J-121	120 1/6W CARBON RES.	
	R786	QRD161J-181	180 1/6W CARBON RES.	
	R786	QRD167J-121	120 1/6W CARBON RES.	
	R787	QRD161J-181	180 1/6W CARBON RES.	
	R787	QRD167J-121	120 1/6W CARBON RES.	
	R788	QRD161J-181	180 1/6W CARBON RES.	
	R788	QRD167J-121	120 1/6W CARBON RES.	
	R801	QRZ0077-220X	22 1/4W FUSIBLE RES.	
	R803	QRD14CJ-821SX	820 1/4W CARBON RES.	
△	R805	QRD14CJ-100SX	10 1/4W UNF. CARBON R	
△	R808	QRD14CJ-2R7S	2.7 1/4W UNF. CARBON R	
△	R821	QRD14CJ-100SX	10 1/4W UNF. CARBON R	
△	R822	QRD14CJ-182SX	1.8K 1/4W UNF. CARBON R	
△	R830	QRZ0077-4R7	4.7 1/4W FUSE RESISTO	
△	R831	QRZ0077-4R7	4.7 1/4W FUSE RESISTO	
△	R832	QRD14CJ-272S	2.7K 1/4W UNF. CARBON R	
△	R840	QRD14CJ-220S	22 1/4W UNF. CARBON R	
△	R841	QRZ0077-100	10 1/4W FUSIBLE RES.	
△	R842	QRD143J-472S	4.7K 1/4W CARBON RES.	
	R845	QRD14CJ-102SX	1K 1/4W UNF. CARBON R	
	R852	QRZ0077-220X	22 1/4W FUSIBLE RES.	
	R853	QRZ0077-220X	22 1/4W FUSIBLE RES.	
△	R854	QRD12CJ-562S	5.6K 1/2W UNF. CARBON R	
△	R860	QRD14CJ-220S	22 1/4W UNF. CARBON R	
	R861	QRD161J-104	100K 1/6W CARBON RES.	
	R862	QRD161J-104	100K 1/6W CARBON RES.	
	R885	QRD161J-104	100K 1/6W CARBON RES.	
△	R891	QRD14CJ-100SX	10 1/4W UNF. CARBON R	
△	R891	QRZ0077-100	10 1/4W FUSIBLE RES.	
△	R892	QRD14CJ-272S	2.7K 1/4W UNF. CARBON R	
	R901	QRD161J-102	1K 1/6W CARBON RES.	
	R902	QRD161J-102	1K 1/6W CARBON RES.	
	R903	QRD167J-153	15K 1/6W CARBON RES.	
	R904	QRD167J-153	15K 1/6W CARBON RES.	
	R905	QRD161J-123	12K 1/6W CARBON RES.	
	R906	QRD161J-123	12K 1/6W CARBON RES.	
	R909	QRD161J-104	100K 1/6W CARBON RES.	
	R910	QRD161J-823	82K 1/6W CARBON RES.	
	R911	QRD167J-332	3.3K 1/6W CARBON RES.	
	R912	QRD161J-473	47K 1/6W CARBON RES.	
	R913	QRD161J-103	10K 1/6W CARBON RES.	
	R915	QRD161J-823	82K 1/6W CARBON RES.	
	R916	QRD161J-563	56K 1/6W CARBON RES.	
	R917	QRD161J-683	68K 1/6W CARBON RES.	
	R918	QRD161J-392	3.9K 1/6W CARBON RES.	
	R919	QRD161J-122	1.2K 1/6W CARBON RES.	
	R920	QRD161J-224	220K 1/6W CARBON RES.	
△	R921	QRD14CJ-470SX	47 1/4W UNF. CARBON R	
	R925	QRD167J-562	5.6K 1/6W CARBON RES.	
	R926	QRD167J-822	8.2K 1/6W CARBON RES.	
	R927	QRD161J-103	10K 1/6W CARBON RES.	



■ Electrical Parts List (ENH-301)

△	Item	Parts Number	Description	Area
	R929	QRD161J-333	33K 1/6W CARBON RES.	
	R930	QRD161J-333	33K 1/6W CARBON RES.	
△	R931	QRZ0077-4R7	4.7 1/4W FUSE RESISTO	
△	R932	QRZ0077-4R7	4.7 1/4W FUSE RESISTO	
△	R951	QRD14CJ-220S	22 1/4W UNF. CARBON R	
	R955	QRD161J-102	1K 1/6W CARBON RES.	
	R956	QRD161J-333	33K 1/6W CARBON RES.	
	R957	QRD161J-104	100K 1/6W CARBON RES.	
	R958	QRD161J-104	100K 1/6W CARBON RES.	
△	R961	QRG022J-471A	470 2W OXIDE METAL	
△	R962	QRG022J-471A	470 2W OXIDE METAL	
△	R971	QRZ0077-4R7	4.7 1/4W FUSE RESISTO	
△	R981	QRZ0077-4R7	4.7 1/4W FUSE RESISTO	
△	R982	QRZ0077-4R7	4.7 1/4W FUSE RESISTO	
	VR741	QVPA601-102A	1K VARIABLE RES.	
	VR742	QVPA601-102A	1K VARIABLE RES.	
		OTHERS		
		EMW10678-105	PRINTED BOARD	EF
		EMW10678-105	PRINTED BOARD	EN
		EMW10678-105	PRINTED BOARD	G
		QWE880-38RR	VINYL WIRE	EF
		QWE880-38RR	VINYL WIRE	EN
		QWE880-38RR	VINYL WIRE	G
		QWE881-16RR	VINYL WIRE	EF
		QWE881-16RR	VINYL WIRE	EN
		QWE881-16RR	VINYL WIRE	G
		QWE882-38RR	VINYL WIRE	EF
		QWE882-38RR	VINYL WIRE	EN
		QWE882-38RR	VINYL WIRE	G
		QWE883-16RR	VINYL WIRE	
		QWE884-20RR	VINYL WIRE	
		QWE886-16RR	PIN WIRE	EF
		QWE886-16RR	PIN WIRE	EN
		QWE886-16RR	PIN WIRE	G
		SBSG3008CC	TAPPING SCREW	
	J955	EMN00TV-118A	PIN JACK	
	J961	GMS6022-V01	MICROPHONE JACK	
	L501	EQL0011-R45J1	INDUCTOR	
	L581	EQL0011-R45J1	INDUCTOR	
	L771	EQL0011-R45J1	INDUCTOR	
	L772	EQL0011-R45J1	INDUCTOR	
	L931	EQL0011-R45J1	INDUCTOR	
	L932	EQL0011-R45J1	INDUCTOR	
	L971	EQL0011-R45J1	INDUCTOR	
	L981	EQL0011-R45J1	INDUCTOR	
	S901	QST4101-E15	PUSH SWITCH	
△	T801	ETP1000-41EA	POWER TRASNFORMER	EF EN
	CN711	EMV7163-010	CONNECT TERMINAL	
	CN713	EMV7163-005	CONNECTOR	
	CN802	EMV7145-004Z	SOCKET ASSY	
	CN803	EMV7145-004Z	SOCKET ASSY	
	CN831	EMV7145-003Z	SOCKET ASSY	
	CN851	EMV7163-007	CONNECT TERMINAL	
	CN955	EMV7163-004	CONNECT TERMINAL	
	CN965	EMV5163-004R	CONNECT TERMINAL	
	EP110	EMZ4002-002Z	EARTH PLATE	
	EP500	EMZ4002-002Z	EARTH PLATE	
	EP800	E409182-001SM	EARTH TERMINAL	
	EP901	E409182-001SM	EARTH TERMINAL	
	EP961	EMZ4002-002Z	EARTH PLATE	
	FC801	EMG7331-003Z	FUSE CLIP	
	FC802	EMG7331-003Z	FUSE CLIP	
	FC803	EMG7331-003Z	FUSE CLIP	
	FC804	EMG7331-003Z	FUSE CLIP	
	FC810	EMG7331-003Z	FUSE CLIP	
	FC811	EMG7331-003Z	FUSE CLIP	
	FC812	EMG7331-003Z	FUSE CLIP	
	FC813	EMG7331-003Z	FUSE CLIP	
	FW801	EWR34D-13SS	FLAT WIRE	
	FW831	EWR33D-10LS	FLAT WIRE	
	FW901	EWR34D-40SS	FLAT WIRE ASSY	
	FW902	EWR35B-16SST	FLAT WIRE	
	FW961	EWR33D-16SS	CORD	

△	Item	Parts Number	Description	Area
	HS841	E70306-001	HEAT SINK	
	HS851	E70945-H40B	HEAT SINK	
	HS981	E70306-001	HEAT SINK	
	LA101	E67132-T2R0	FUSE LABEL	
	RY801	ESK1D12-119J3	RELAY	
	RY860	QSK0064-001	RELAY	
	RY901	ESK7D24-213R	RELAY	
	RY951	ESK7D24-213R	RELAY	
	ST901	EMB90YV-401A	SPEAKER TERMINAL	
	ST951	EMB90TV-602G	SPEAKER TERMINAL	
	SW001	QSW0467-001	PUSH SWITCH	EF EN
	TA801	EMZ4001-002Z	TAB	
	TA802	EMZ4001-002Z	TAB	
	TH540	ERT-D2WHL202S	NEGATIVE THERMISTOR	
	TH568	ERT-D2WHL202S	NEGATIVE THERMISTOR	
	TH749	ERT-D2WHL202S	NEGATIVE THERMISTOR	
	TH750	ERT-D2WHL202S	NEGATIVE THERMISTOR	
	TP001	GMV5005-004K	PLUG ASSY	

■ Electrical Parts List (ENP-055)

△	Item	Parts Number	Description	Area
		I. C. S		
	IC031	SAA7367TX	I. C (DIGI-MOS)	
	IC041	PCM1717AE-X	I. C (MONO-ANALOG)	
	IC041	PCM1717E	I. C (MONO-ANALOG)	
	IC051	NJM2100MW	I. C (MONO-ANALOG)	
	IC061	PCM1717AE-X	I. C (MONO-ANALOG)	
	IC061	PCM1717E	I. C (MONO-ANALOG)	
	IC071	BA15218F	I. C (MONO-ANALOG)	
	IC081	TMS57052BFT	I. C (M)	
	IC091	LC32464M-80X	I. C (D-RAM)	
		CAPACITORS		
	C021	NEA21EM-475NZ	4.7MF 25V AL E. CAP.	
	C022	NEA21EM-475NZ	4.7MF 25V AL E. CAP.	
	C023	NCB31CK-473AY	0.047MF 16V CER. CAP.	
	C024	NCB31CK-473AY	0.047MF 16V CER. CAP.	
	C025	NEA20GM-476NZ	47MF AL E. CAP.	
	C026	NEA20GM-476NZ	47MF AL E. CAP.	
	C027	NCS31HJ-680AY	68PF 50V CER. CAP.	
	C028	NCS31HJ-680AY	68PF 50V CER. CAP.	
	C029	NCB31CK-473AY	0.047MF 16V CER. CAP.	
	C030	NEA20JM-476NZ	47MF 6.3V AL E. CAP.	
	C031	NCB31CK-223A	0.022MF 16V CER. CAP.	
	C035	NCB31HK-102AY	1000PF 50V CER. CAP.	
	C036	NCB31HK-102AY	1000PF 50V CER. CAP.	
	C037	NCF31AZ-105AY	1MF 10V CER. CAP.	
	C038	NCF31AZ-105AY	1MF 10V CER. CAP.	
	C041	NEA21CM-106NZ	10MF 16V AL E. CAP.	
	C042	NEA21CM-106NZ	10MF 16V AL E. CAP.	
	C045	NCB31HK-102AY	1000PF 50V CER. CAP.	
	C046	NCB31HK-102AY	1000PF 50V CER. CAP.	
	C047	NCF31AZ-105AY	1MF 10V CER. CAP.	
	C048	NCF31AZ-105AY	1MF 10V CER. CAP.	
	C049	NCS31HJ-220AY	22PF 50V CER. CAP.	
	C050	NCS31HJ-220AY	22PF 50V CER. CAP.	
	C051	NCB31CK-223A	0.022MF 16V CER. CAP.	
	C052	NCB31CK-223A	0.022MF 16V CER. CAP.	
	C053	NCB21HK-182AY	1800PF 50V CER. CAP.	
	C054	NCB21HK-182AY	1800PF 50V CER. CAP.	
	C055	NCB31CK-103AYM	0.01MF 16V CER. CAP.	
	C056	NCB31CK-103AYM	0.01MF 16V CER. CAP.	
	C057	NEA21HM-105NZ	1MF 50V AL E. CAP.	
	C058	NEA21HM-105NZ	1MF 50V AL E. CAP.	
	C059	NCF31AZ-105AY	1MF 10V CER. CAP.	
	C060	NCB31CK-103AYM	0.01MF 16V CER. CAP.	
	C061	NEA21CM-106NZ	10MF 16V AL E. CAP.	
	C062	NEA21CM-106NZ	10MF 16V AL E. CAP.	
	C065	NCB31HK-102AY	1000PF 50V CER. CAP.	
	C066	NCB31HK-102AY	1000PF 50V CER. CAP.	
	C067	NCF31AZ-105AY	1MF 10V CER. CAP.	
	C068	NCF31AZ-105AY	1MF 10V CER. CAP.	
	C071	NCB31CK-223A	0.022MF 16V CER. CAP.	
	C072	NCB31CK-223A	0.022MF 16V CER. CAP.	
	C073	NCB21HK-182AY	1800PF 50V CER. CAP.	
	C074	NCB21HK-182AY	1800PF 50V CER. CAP.	
	C075	NCB31CK-103AYM	0.01MF 16V CER. CAP.	
	C076	NCB31CK-103AYM	0.01MF 16V CER. CAP.	
	C077	NEA21HM-105NZ	1MF 50V AL E. CAP.	
	C078	NEA21HM-105NZ	1MF 50V AL E. CAP.	
	C079	NCF31AZ-105AY	1MF 10V CER. CAP.	
	C080	NCB31CK-103AYM	0.01MF 16V CER. CAP.	
	C081	NCB31HK-102AY	1000PF 50V CER. CAP.	
	C082	NCB31HK-102AY	1000PF 50V CER. CAP.	
	C083	NCB31HK-102AY	1000PF 50V CER. CAP.	
	C084	NCB31HK-102AY	1000PF 50V CER. CAP.	
	C085	NCB31HK-102AY	1000PF 50V CER. CAP.	
	C086	NCB31HK-102AY	1000PF 50V CER. CAP.	
	C087	NCB31HK-102AY	1000PF 50V CER. CAP.	
	C088	NCB31HK-102AY	1000PF 50V CER. CAP.	
	C089	NCB31HK-102AY	1000PF 50V CER. CAP.	
	C091	NCB31HK-102AY	1000PF 50V CER. CAP.	
	C092	NCF31AZ-105AY	1MF 10V CER. CAP.	
	C095	NCF31AZ-105AY	1MF 10V CER. CAP.	
	C096	NCF31AZ-105AY	1MF 10V CER. CAP.	
	C097	NEA20JM-107NPM	100MF 6.3V E. CAP.	
	C098	NEA20JM-107NPM	100MF 6.3V E. CAP.	
	C099	NCS31HJ-101AY	100PF 50V CER. CAP.	

△	Item	Parts Number	Description	Area
	C100	NCB31HK-102AY	1000PF 50V CER. CAP.	
		RESISTORS		
	R021	NRSA63J-104NY	METAL GLAZE	
	R022	NRSA63J-104NY	METAL GLAZE	
	R023	NRSA63J-103N	METAL GLAZE	
	R024	NRSA63J-103N	METAL GLAZE	
	R025	NRSA63J-624NY	METAL GLAZE	
	R026	NRSA63J-334NY	METAL GLAZE	
	R027	NRSA63F-103NY	METAL GLAZE	
	R028	NRSA63F-103NY	METAL GLAZE	
	R029	NRSA63J-271NY	METAL GLAZE	
	R030	NRSA63J-271NY	METAL GLAZE	
	R031	NRSA63J-333NY	METAL GLAZE	
	R035	NRSA63J-102NY	METAL GLAZE	
	R049	NRSA63J-332NY	METAL GLAZE	
	R051	NRSA63J-102NY	METAL GLAZE	
	R052	NRSA63J-102NY	METAL GLAZE	
	R053	NRSA63J-102NY	METAL GLAZE	
	R054	NRSA63J-102NY	METAL GLAZE	
	R055	NRSA63J-102NY	METAL GLAZE	
	R056	NRSA63J-102NY	METAL GLAZE	
	R057	NRSA63J-473NY	METAL GLAZE	
	R058	NRSA63J-473NY	METAL GLAZE	
	R059	NRSA63J-221NY	METAL GLAZE	
	R060	NRSA63J-221NY	METAL GLAZE	
	R071	NRSA63J-102NY	METAL GLAZE	
	R072	NRSA63J-102NY	METAL GLAZE	
	R073	NRSA63J-102NY	METAL GLAZE	
	R074	NRSA63J-102NY	METAL GLAZE	
	R075	NRSA63J-102NY	METAL GLAZE	
	R076	NRSA63J-102NY	METAL GLAZE	
	R077	NRSA63J-473NY	METAL GLAZE	
	R078	NRSA63J-473NY	METAL GLAZE	
	R079	NRSA63J-221NY	METAL GLAZE	
	R080	NRSA63J-221NY	METAL GLAZE	
	R081	NRSA63J-102NY	METAL GLAZE	
	R082	NRSA63J-102NY	METAL GLAZE	
	R083	NRSA63J-102NY	METAL GLAZE	
	R084	NRSA63J-182NY	METAL GLAZE	
	R085	NRSA63J-472NY	METAL GLAZE	
	R086	NRSA63J-472NY	METAL GLAZE	
	R087	NRSA63J-472NY	METAL GLAZE	
	R090	NRSA63J-103N	METAL GLAZE	
	R091	NRSA63J-OR0AY	METAL GLAZE	
	R092	NRSA63J-OR0AY	METAL GLAZE	
	R093	NRSA63J-OR0AY	METAL GLAZE	
	R094	NRSA63J-OR0AY	METAL GLAZE	
	R095	NRSA63J-OR0AY	METAL GLAZE	
	R096	NRSA63J-OR0AY	METAL GLAZE	
	R097	NRSA63J-OR0AY	METAL GLAZE	
		OTHERS		
		EMW10661-102A	PRINTED BOARD	
	K021	EQA0002-N102Y	FERRITE BEADS	
	K022	EQA0002-N102Y	FERRITE BEADS	
	K041	EQA0002-N102Y	FERRITE BEADS	
	K042	EQA0002-N102Y	FERRITE BEADS	
	K051	EQA0002-N102Y	FERRITE BEADS	
	K052	EQA0002-N102Y	FERRITE BEADS	
	K061	EQA0002-N102Y	FERRITE BEADS	
	K062	EQA0002-N102Y	FERRITE BEADS	
	K063	EQA0002-N102Y	FERRITE BEADS	
	K071	EQA0002-N102Y	FERRITE BEADS	
	K072	EQA0002-N102Y	FERRITE BEADS	
	K095	EQA0002-N102Y	FERRITE BEADS	
	K096	EQA0002-N102Y	FERRITE BEADS	
	X041	NAX0001-001X	CRYSTAL	
	CN095	EMV5158-018E	CONNECT TERMINAL	
	LC031	EQF0704-N01YU	INDUCTOR	
	LC041	EQF0704-N01YU	INDUCTOR	
	LC081	EQF0703-N103MZ	INDUCTOR	
	LC091	EQF0703-N103NZ	INDUCTOR	



■ Electrical Parts List (ENA-178)

△	Item	Parts Number	Description	Area
		I. C. S		
	IC102	LA1837	I. C (MONO-ANALOG)	
	IC121	LC72131	I. C (M)	
	IC191	LC7073	I. C (DIGI-MOS)	
	IC192	SAA6579	I. C (M)	
		DIODES		
	D121	1SS133	SI. DIODE	
	D123	1SS133	SI. DIODE	
	D129	1SS133	SI. DIODE	
	D130	MTZ10JC	ZENER DIODE	
	D131	1SS133	SI. DIODE	
		TRANSISTORS		
	Q101	2SC461	SI. TRANSISTOR	
	Q102	2SC535	SI. TRANSISTOR	
	Q103	2SC461	SI. TRANSISTOR	
	Q111	2SD2144S (VW)	SI. TRANSISTOR	
	Q112	2SD2144S (VW)	SI. TRANSISTOR	
	Q113	2SD2144S (VW)	SI. TRANSISTOR	
	Q114	2SD2144S (VW)	SI. TRANSISTOR	
	Q121	DTA124ES	DIGITAL TRANSISTOR	
	Q123	2SC2060 (Q, R)	SI. TRANSISTOR	
		CAPACITORS		
	C101	QCVB1CM-103Y	0.01MF 16V CER. CAP.	
	C102	QETN1EM-107Z	100MF 25V E. CAP.	
	C103	QCHB1EZ-223	0.022MF 25V CER. CAP.	
	C104	QCHB1EZ-223	0.022MF 25V CER. CAP.	
	C105	QCHB1EZ-223	0.022MF 25V CER. CAP.	
	C107	QETN1EM-226Z	22MF 25V E. CAP.	
	C109	QETN1EM-226Z	22MF 25V E. CAP.	
	C111	QCHB1EZ-223	0.022MF 25V CER. CAP.	
	C112	QCT30CH-120Y	12PF 50V CER. CAP.	
	C113	QCHB1EZ-223	0.022MF 25V CER. CAP.	
	C117	QCSB1HK-5R6Y	5.6PF 50V CER. CAP.	
	C118	QCSB1HJ-150Y	15PF 50V CER. CAP.	
	C121	QCT30CH-180Y	18PF 50V CER. CAP.	
	C122	QCT30CH-180Y	18PF 50V CER. CAP.	
	C123	QCC21EM-473	0.047MF 25V CER. CAP.	
	C126	QCB1HK-101Y	100PF 50V CER. CAP.	
	C128	QENB1HM-474	0.47MF 50V NP E. CAP.	
	C129	QCG1HK-102	1000PF 50V CER. CAP.	
	C130	QETN1EM-107Z	100MF 25V E. CAP.	
	C133	QETN1EM-226Z	22MF 25V E. CAP.	
	C134	QCB1HK-331Y	330PF 50V CER. CAP.	
	C135	QCHB1EZ-223	0.022MF 25V CER. CAP.	
	C136	QETN1HM-105Z	1MF 50V AL E. CAP.	
	C137	QCB1HK-391Y	390PF 50V CER. CAP.	
	C139	QFLB1HJ-473	0.047MF 50V MYLAR CAP.	
	C140	QFLB1HJ-473	0.047MF 50V MYLAR CAP.	
	C141	QCC21EM-473	0.047MF 25V CER. CAP.	
	C143	QCHB1EZ-223	0.022MF 25V CER. CAP.	
	C144	QCC21EM-473	0.047MF 25V CER. CAP.	
	C146	QETN1HM-105Z	1MF 50V AL E. CAP.	
	C147	QETN1HM-105Z	1MF 50V AL E. CAP.	
	C148	QETN1HM-474Z	0.47MF 50V AL E. CAP.	
	C149	QETN1HM-105Z	1MF 50V AL E. CAP.	
	C150	QETN1EM-226Z	22MF 25V E. CAP.	
	C156	QCHB1EZ-223	0.022MF 25V CER. CAP.	
	C157	QCC21EM-473	0.047MF 25V CER. CAP.	
	C158	QETN1EM-226Z	22MF 25V E. CAP.	
	C161	QETN1HM-105Z	1MF 50V AL E. CAP.	
	C162	QETN1HM-105Z	1MF 50V AL E. CAP.	
	C163	QCHB1EZ-223	0.022MF 25V CER. CAP.	
	C164	QCC21EM-473	0.047MF 25V CER. CAP.	
	C168	QFV81HJ-274	0.27MF 50V THIN FILM CAP.	
	C180	QETN1EM-107Z	100MF 25V E. CAP.	
	C181	QFLB1HJ-562	5600PF 50V MYLAR CAP.	
	C182	QFLB1HJ-562	5600PF 50V MYLAR CAP.	
	C183	QCHB1EZ-223	0.022MF 25V CER. CAP.	
	C184	QETN1EM-107Z	100MF 25V E. CAP.	
	C185	QETN1HM-105Z	1MF 50V AL E. CAP.	
	C186	QETN1HM-105Z	1MF 50V AL E. CAP.	
	C191	QCB1HK-820Y	82PF 50V CER. CAP.	
	C192	QCSB1HJ-470	47PF 50V CER. CAP.	
	C193	QCB1HK-561Y	560PF 50V CER. CAP.	
	C194	QCHB1EZ-223	0.022MF 25V CER. CAP.	
	C195	QCB1HK-331Y	330PF 50V CER. CAP.	

△	Item	Parts Number	Description	Area
	C196	QETN1EM-226Z	22MF 25V E. CAP.	
	C197	QCZ0205-155	1.5MF 25V C. CAP.	
	C199	QETN1EM-226Z	22MF 25V E. CAP.	
		RESISTORS		
	R102	QRD167J-332	3.3K 1/6W CARBON RES.	
	R103	QRD161J-221	220 1/6W CARBON RES.	
	R104	QRD167J-272	2.7K 1/6W CARBON RES.	
	R105	QRD161J-391	390 1/6W CARBON RES.	
	R106	QRD161J-102	1K 1/6W CARBON RES.	
	R107	QRD161J-561	560 1/6W CARBON RES.	
	R108	QRD167J-332	3.3K 1/6W CARBON RES.	
	R109	QRD161J-221	220 1/6W CARBON RES.	
	R110	QRD161J-472	4.7K 1/6W CARBON RES.	
	R111	QRD161J-472	4.7K 1/6W CARBON RES.	
	R112	QRD161J-472	4.7K 1/6W CARBON RES.	
	R113	QRD161J-103	10K 1/6W CARBON RES.	
	R114	QRD161J-122	1.2K 1/6W CARBON RES.	
	R115	QRD161J-104	100K 1/6W CARBON RES.	
	R116	QRD161J-472	4.7K 1/6W CARBON RES.	
	R119	QRD161J-103	10K 1/6W CARBON RES.	
	R121	QRD161J-473	47K 1/6W CARBON RES.	
	R122	QRD161J-472	4.7K 1/6W CARBON RES.	
	R124	QRD161J-222	2.2K 1/6W CARBON RES.	
	R126	QRD167J-562	5.6K 1/6W CARBON RES.	
	R127	QRD167J-822	8.2K 1/6W CARBON RES.	
	R128	QRD161J-472	4.7K 1/6W CARBON RES.	
	R129	QRD161J-222	2.2K 1/6W CARBON RES.	
△	R130	QRZ0077-680	68 1/4W FUSIBLE RES.	
	R131	QRD161J-103	10K 1/6W CARBON RES.	
	R132	QRD161J-102	1K 1/6W CARBON RES.	
	R133	QRD167J-822	8.2K 1/6W CARBON RES.	
	R134	QRD161J-102	1K 1/6W CARBON RES.	
	R140	QRD161J-563	56K 1/6W CARBON RES.	
	R141	QRD161J-472	4.7K 1/6W CARBON RES.	
	R142	QRD161J-470	47 1/6W CARBON RES.	
	R143	QRD167J-562	5.6K 1/6W CARBON RES.	
	R144	QRD167J-332	3.3K 1/6W CARBON RES.	
	R145	QRD161J-103	10K 1/6W CARBON RES.	
	R146	QRD167J-562	5.6K 1/6W CARBON RES.	
	R147	QRD161J-273	27K 1/6W CARBON RES.	
	R148	QRD161J-561	560 1/6W CARBON RES.	
	R150	QRD161J-101	100 1/6W CARBON RES.	
	R157	QRD161J-182	1.8K 1/6W CARBON RES.	
	R158	QRD161J-182	1.8K 1/6W CARBON RES.	
	R161	QRD161J-102	1K 1/6W CARBON RES.	
	R162	QRD161J-102	1K 1/6W CARBON RES.	
	R163	QRD161J-472	4.7K 1/6W CARBON RES.	
	R164	QRD161J-472	4.7K 1/6W CARBON RES.	
	R181	QRD161J-102	1K 1/6W CARBON RES.	
	R182	QRD161J-103	10K 1/6W CARBON RES.	
	R183	QRD161J-103	10K 1/6W CARBON RES.	
	R184	QRD161J-103	10K 1/6W CARBON RES.	
	R191	QRD161J-222	2.2K 1/6W CARBON RES.	
		OTHERS		
		EMW10684-003A	PRINTED BOARD	
	L111	EOL4007-150T	INDUCTOR	
	T111	EQR7121-006	RF COIL	
	T141	QQR0613-001	I. F. TRANSFORMER	
	T142	QAX0303-001	CERAMIC FILTER	
	X121	ECX0007-200KWJ1	CRYSTAL	
	X191	VX5057-001	CRYSTAL	
	X192	EFO-EC4004T4	CERAMIC RESONATOR	
	AT101	EMB41YV-302K	ANTENNA TERMINAL	
	BK001	E308963-002	SHIELD BRACKET	
	BK001	E308963-223SM	SHIELD BRACKET	
	CF101	QAX0285-001Z	CERAMIC FILTER	
	CF102	QAX0285-001Z	CERAMIC FILTER	
	CN111	EMV5163-012R	CONNECT TERMINAL	
	CN112	EMV5109-005A	MALE CONNECTOR	
	FL141	EQF0101-013	LOWPASS FILTER	
	FL142	EQF0101-013	LOWPASS FILTER	
	RF101	QAU0005-001	FRONT END	

■ Electrical Parts List (ENB-245)

△	Item	Parts Number	Description	Area
		I. C. S		
	IC401	MN101C01DAA1	I. C. (M)	
	IC402	GP1U271X	INFRARED DETECT UNIT	
	IC403	PST600E-T	I. C. (MONO-ANALOG)	
	IC411	MN171602JAAN	I. C. (MICRO-COMPUTER)	
		DIODES		
	D401	1SR139-200	SI. DIODE	
	D402	1SS133	SI. DIODE	
	D403	1SS133	SI. DIODE	
	D404	1SS133	SI. DIODE	
	D410	1SS133	SI. DIODE	
	D411	SLA-380JT3F	L. E. D.	
	D412	SLR-342MCA47	L. E. D.	
	D413	SLR-342MCA47	L. E. D.	
	D414	SLR-342MCA47	L. E. D.	
	D415	SLR-342MCA47	L. E. D.	
	D416	SLR-342MCA47	L. E. D.	
	D417	SLR-342MCA47	L. E. D.	
	D418	SLR-342MCA47	L. E. D.	
	D419	SLR-342MCA47	L. E. D.	
	D420	SLR-342MCA47	L. E. D.	
	D421	SLR-342MCA47	L. E. D.	
	D422	SLR-342MCA47	L. E. D.	
	D423	SLR-342MCA47	L. E. D.	
	D424	SLR-342MCA47	L. E. D.	
	D425	SLR-342DCA47	L. E. D.	
	D426	SLR-342DCA47	L. E. D.	
	D431	1SS133	SI. DIODE	
	D432	1SS133	SI. DIODE	
	D433	1SS133	SI. DIODE	
	D434	1SS133	SI. DIODE	
	D435	1SS133	SI. DIODE	
	D436	1SS133	SI. DIODE	
	D438	1SS133	SI. DIODE	
	D445	1SS133	SI. DIODE	
	D553	1SS133	SI. DIODE	
	D703	1SS133	SI. DIODE	
	D704	1SS133	SI. DIODE	
	D711	SLR-342MG-TA	L. E. D.	
	D712	SLR-342MG-TA	L. E. D.	
		TRANSISTORS		
	Q401	DTC114YS	DIGITAL TRANSISTOR	
	Q402	DTC114TN	DIGITAL TRANSISTOR	
	Q403	DTC144WS	DIGITAL TRANSISTOR	
	Q407	DTC114ES	DIGITAL TRANSISTOR	
	Q408	DTC114ES	DIGITAL TRANSISTOR	
	Q409	DTC114ES	DIGITAL TRANSISTOR	
	Q410	DTC114YS	DIGITAL TRANSISTOR	
	Q411	DTC114YS	DIGITAL TRANSISTOR	
	Q412	DTC114YS	DIGITAL TRANSISTOR	
	Q413	DTC114YS	DIGITAL TRANSISTOR	
	Q414	DTC114YS	DIGITAL TRANSISTOR	
	Q415	DTC114ES	DIGITAL TRANSISTOR	
	Q551	2SC2240 (BL)	SI. TRANSISTOR	
	Q552	2SC2240 (BL)	SI. TRANSISTOR	
	Q561	2SA1038 (R. S)	SI. TRANSISTOR	
	Q701	2SC2240 (BL)	SI. TRANSISTOR	
	Q702	2SC2240 (BL)	SI. TRANSISTOR	
	Q703	2SC2240 (BL)	SI. TRANSISTOR	
	Q704	2SC2240 (BL)	SI. TRANSISTOR	
	Q707	2SA1038 (R. S)	SI. TRANSISTOR	
	Q708	2SA1038 (R. S)	SI. TRANSISTOR	
	Q711	2SC2389 (S. E)	SI. TRANSISTOR	
	Q712	2SC2389 (S. E)	SI. TRANSISTOR	
		CAPACITORS		
	C401	QETB1AM-227	220MF 10V E. CAP.	
	C402	QEAD0HZ-10AZM	AL E. CAP.	
	C404	QETB1HM-225	2.2MF 50V AL E. CAP.	
	C405	QCHB1EZ-223	0.022MF 25V CER. CAP.	
	C406	QCB1HK-331Y	330PF 50V CER. CAP.	

△	Item	Parts Number	Description	Area
	C410	QETB1HM-475E	4.7MF 50V E. CAP.	
	C411	QETB1HM-475E	4.7MF 50V E. CAP.	
	C412	QETB1HM-475E	4.7MF 50V E. CAP.	
	C413	QCZO202-155	1.5MF 25V CER. RES.	
	C414	QETB1AM-107	100MF 10V AL E. CAP.	
	C415	QETB1AM-227	220MF 10V E. CAP.	
	C416	QCZO202-155	1.5MF 25V CER. RES.	
	C421	QCVB1CM-103Y	0.01MF 16V CER. CAP.	
	C422	QCF21HP-103A	0.01MF 50V CER. CAP.	
	C422	QCZO202-155	1.5MF 25V CER. RES.	
	C423	QCB1HK-221Y	220PF 50V CER. CAP.	
	C551	QETB1HM-106	10MF 50V E. CAP.	
	C552	QCS21HJ-271A	270PF 50V CER. CAP.	
	C553	QCS21HJ-101A	100PF 50V CER. CAP.	
	C556	QCY31HK-152Z	1500PF 50V CER. CAP.	
	C557	QCS21HJ-100	10PF 50V CER. CAP.	
	C558	QETB1CM-476	47MF 16V AL E. CAP.	
	C561	QETB1HM-225	2.2MF 50V AL E. CAP.	
	C562	QCS22HJ-330	33PF 500V CER. CAP.	
	C563	QFLB1HJ-103	0.01MF 50V MYLAR CAP.	
	C564	QETB1HM-476	47MF 50V E. CAP.	
	C701	QETB1HM-106	10MF 50V E. CAP.	
	C702	QETB1HM-106	10MF 50V E. CAP.	
	C703	QCS21HJ-271A	270PF 50V CER. CAP.	
	C704	QCS21HJ-271A	270PF 50V CER. CAP.	
	C705	QCS21HJ-101A	100PF 50V CER. CAP.	
	C706	QCS21HJ-101A	100PF 50V CER. CAP.	
	C711	QETB1CM-107	100MF 16V AL E. CAP.	
	C712	QETB1CM-107	100MF 16V AL E. CAP.	
	C713	QCS21HJ-100	10PF 50V CER. CAP.	
	C714	QCS21HJ-100	10PF 50V CER. CAP.	
	C717	QCY31HK-152Z	1500PF 50V CER. CAP.	
	C718	QCY31HK-152Z	1500PF 50V CER. CAP.	
	C721	QCS22HJ-220	22PF 500V CER. CAP.	
	C722	QCS22HJ-220	22PF 500V CER. CAP.	
	C723	QETB1HM-225	2.2MF 50V AL E. CAP.	
	C724	QETB1HM-225	2.2MF 50V AL E. CAP.	
	C727	QFLB1HJ-104	0.1MF 50V MYLAR CAP.	
	C728	QFLB1HJ-104	0.1MF 50V MYLAR CAP.	
	C739	QETB1HM-107	100MF 63V AL E. CAP.	
		RESISTORS		
	R402	QRD161J-470	47 1/6W CARBON RES.	
	R403	QRD161J-104	100K 1/6W CARBON RES.	
	R406	QRD161J-104	100K 1/6W CARBON RES.	
	R407	QRD161J-104	100K 1/6W CARBON RES.	
	R408	QRD161J-472	4.7K 1/6W CARBON RES.	
	R409	QRD161J-104	100K 1/6W CARBON RES.	
	R410	QRD167J-223	22K 1/6W CARBON RES.	
	R411	QRD161J-472	4.7K 1/6W CARBON RES.	
	R412	QRD161J-103	10K 1/6W CARBON RES.	
	R413	QRD161J-103	10K 1/6W CARBON RES.	
	R414	QRD161J-103	10K 1/6W CARBON RES.	
	R417	QRD161J-103	10K 1/6W CARBON RES.	
	R418	QRD161J-471	470 1/6W CARBON RES.	
	R419	QRD161J-103	10K 1/6W CARBON RES.	
	R420	QRD161J-221	220 1/6W CARBON RES.	
	R421	QRD161J-221	220 1/6W CARBON RES.	
	R422	QRD161J-221	220 1/6W CARBON RES.	
	R423	QRD161J-221	220 1/6W CARBON RES.	
	R424	QRD161J-221	220 1/6W CARBON RES.	
	R425	QRD161J-221	220 1/6W CARBON RES.	
	R426	QRD161J-221	220 1/6W CARBON RES.	
	R427	QRD161J-221	220 1/6W CARBON RES.	
	R434	QRD161J-221	220 1/6W CARBON RES.	
	R435	QRD161J-221	220 1/6W CARBON RES.	
	R436	QRD161J-221	220 1/6W CARBON RES.	
	R437	QRD161J-221	220 1/6W CARBON RES.	
	R438	QRD161J-221	220 1/6W CARBON RES.	
	R439	QRD161J-221	220 1/6W CARBON RES.	
	R440	QRD161J-221	220 1/6W CARBON RES.	

■ Electrical Parts List (ENB-245)

△	Item	Parts Number	Description	Area
	R441	QRD161J-103	10K 1/6W CARBON RES.	
	R442	QRD161J-103	10K 1/6W CARBON RES.	
	R443	QRD161J-221	220 1/6W CARBON RES.	
	R444	QRD161J-221	220 1/6W CARBON RES.	
	R445	QRD161J-221	220 1/6W CARBON RES.	
	R446	QRD161J-221	220 1/6W CARBON RES.	
	R447	QRD161J-221	220 1/6W CARBON RES.	
	R448	QRD161J-221	220 1/6W CARBON RES.	
	R449	QRD161J-221	220 1/6W CARBON RES.	
	R450	QRD161J-221	220 1/6W CARBON RES.	
	R451	QRD161J-221	220 1/6W CARBON RES.	
	R452	QRD161J-221	220 1/6W CARBON RES.	
	R453	QRD161J-221	220 1/6W CARBON RES.	
	R454	QRD161J-221	220 1/6W CARBON RES.	
	R455	QRD161J-221	220 1/6W CARBON RES.	
	R456	QRD161J-221	220 1/6W CARBON RES.	
	R457	QRD161J-221	220 1/6W CARBON RES.	
	R458	QRD161J-221	220 1/6W CARBON RES.	
	R459	QRD161J-221	220 1/6W CARBON RES.	
	R551	QRD161J-222	2. 2K 1/6W CARBON RES.	
	R552	QRD161J-104	100K 1/6W CARBON RES.	
	R553	QRD161J-202	2K 1/6W CARBON RES.	
	R553	QRD161J-222	2. 2K 1/6W CARBON RES.	
	R554	QRD161J-202	2K 1/6W CARBON RES.	
	R554	QRD161J-222	2. 2K 1/6W CARBON RES.	
	R555	QRD161J-123	12K 1/6W CARBON RES.	
	R555	QRD161J-133Y	13K 1/6W CARBON RES.	
	R556	QRD161J-101	100 1/6W CARBON RES.	
	R558	QRD161J-102	1K 1/6W CARBON RES.	
	R560	QRD161J-104	100K 1/6W CARBON RES.	
△	R561	QRD140J-221S	220 1/4W UNF. CARBON R	
△	R561	QRD140J-271S	270 1/4W UNF. CARBON R	
	R563	QRD167J-272	2. 7K 1/6W CARBON RES.	
	R564	QRD167J-272	2. 7K 1/6W CARBON RES.	
	R565	QRD167J-272	2. 7K 1/6W CARBON RES.	
	R566	QRD167J-272	2. 7K 1/6W CARBON RES.	
△	R569	QRD140J-100SX	10 1/4W UNF. CARBON R	
△	R570	QRD140J-100SX	10 1/4W UNF. CARBON R	
	R701	QRD161J-222	2. 2K 1/6W CARBON RES.	
	R702	QRD161J-222	2. 2K 1/6W CARBON RES.	
	R703	QRD161J-104	100K 1/6W CARBON RES.	
	R704	QRD161J-104	100K 1/6W CARBON RES.	
	R705	QRD161J-202	2K 1/6W CARBON RES.	
	R706	QRD161J-202	2K 1/6W CARBON RES.	
	R707	QRD161J-202	2K 1/6W CARBON RES.	
	R708	QRD161J-202	2K 1/6W CARBON RES.	
	R709	QRD161J-123	12K 1/6W CARBON RES.	
	R710	QRD161J-123	12K 1/6W CARBON RES.	
	R711	QRD161J-102	1K 1/6W CARBON RES.	
	R712	QRD161J-102	1K 1/6W CARBON RES.	
	R713	QRD161J-104	100K 1/6W CARBON RES.	
	R714	QRD161J-104	100K 1/6W CARBON RES.	
	R717	QRD161J-101	100 1/6W CARBON RES.	
	R718	QRD161J-101	100 1/6W CARBON RES.	
△	R721	QRD140J-221S	220 1/4W UNF. CARBON R	
△	R721	QRD140J-271S	270 1/4W UNF. CARBON R	
△	R722	QRD140J-221S	220 1/4W UNF. CARBON R	
△	R722	QRD140J-271S	270 1/4W UNF. CARBON R	
	R727	QRD161J-473	47K 1/6W CARBON RES.	
	R728	QRD161J-473	47K 1/6W CARBON RES.	
	R729	QRD140J-331SX	330 1/4W UNF. CARBON R	
	R730	QRD140J-331SX	330 1/4W UNF. CARBON R	
△	R739	QRD140J-100SX	10 1/4W UNF. CARBON R	
△	R740	QRD140J-100SX	10 1/4W UNF. CARBON R	
	RA401	QRB049J-103	10K 1/10WRES.	
		OTHERS		
		EMW10681-003	PRINTED BOARD	
	S401	ESP0001-023M	TACT SWITCH	
	S402	ESP0001-023M	TACT SWITCH	
	S403	ESP0001-023M	TACT SWITCH	

△	Item	Parts Number	Description	Area
	S404	ESP0001-023M	TACT SWITCH	
	S405	ESP0001-023M	TACT SWITCH	
	S406	ESP0001-023M	TACT SWITCH	
	S407	ESP0001-023M	TACT SWITCH	
	S408	ESP0001-023M	TACT SWITCH	
	S409	ESP0001-023M	TACT SWITCH	
	S410	ESP0001-023M	TACT SWITCH	
	S411	ESP0001-023M	TACT SWITCH	
	S412	ESP0001-023M	TACT SWITCH	
	S413	ESP0001-023M	TACT SWITCH	
	S414	ESP0001-023M	TACT SWITCH	
	S415	ESP0001-023M	TACT SWITCH	
	S416	ESP0001-023M	TACT SWITCH	
	S417	ESP0001-023M	TACT SWITCH	
	S418	ESP0001-023M	TACT SWITCH	
	S419	ESP0001-023M	TACT SWITCH	
	S420	ESP0001-023M	TACT SWITCH	
	S421	ESP0001-023M	TACT SWITCH	
	X401	ECX0008-000KMZ	CRYSTAL	
	X411	ECXP6R0-001ZA	CRYSTAL	
	CN315	VMC0163-029	CONNECT TERMINAL	
	CN412	EWS265-A426	SOCKET WIRE ASSY	
	CN612	EWS263-A434J	SOCKET WIRE ASSY	
	CN613	EWS296-0134	SOCKET WIRE ASSY	
	CN701	EMV5163-010R	CONNECT TERMINAL	
	CN703	EMV5163-005R	CONNECTOR	
	CN712	EMV5109-006B	CONNECT TERMINAL	
	D1401	QLF0002-001	FLUORESCENT DISPLAY TUBE	
	FH001	E309106-001SM	FL HOLDER	
	FS001	E3400-444	FELT SPACER	
	FS002	E3400-444	FELT SPACER	
	FS422	E3400-431	FELT SPACER	
	FS423	E3400-431	FELT SPACER	
	FW401	EWR38D-16LS	FLAT WIRE	
	JS401	QSJ4003-E01	PUSH SWITCH	
	SP401	VYH7653-002	I. C. PROTECTOR	

■ Electrical Parts List (ENC-135)

△	Item	Parts Number	Description	Area
		I. C. S		
	IC201	TC9212P	I. C (DIGI-MOS)	
	IC202	TC9212P	I. C (DIGI-MOS)	
	IC203	BA15218N	I. C (MONO-ANALOG)	
	IC204	BA15218	I. C (MONO-ANALOG)	
	IC251	MS243P12	I. C (MONO-ANALOG)	
	IC252	TC9163AN	I. C (DIGI-MOS)	
	IC321	TC9164AN	I. C (DIGI-MOS)	
	IC331	BA15218N	I. C (MONO-ANALOG)	
	IC341	BA15218	I. C (MONO-ANALOG)	
	IC351	UPD4066BC	I. C (DIGI-MOS)	
	IC361	BA15218	I. C (MONO-ANALOG)	
	IC671	NJM2246D	I. C (MONO-ANALOG)	
	IC672	BA7604N	I. C (MONO-ANALOG)	
	IC673	M35012-120SP	I. C (M)	
		DIODES		
	D251	MT26. 8JC	ZENER DIODE	
	D252	MT26. 8JC	ZENER DIODE	
	D353	MT28. 2JC	ZENER DIODE	
	D354	MT28. 2JC	ZENER DIODE	
	D671	1SS133	SI. DIODE	
	D672	1SS133	SI. DIODE	
	D673	1SS133	SI. DIODE	
		TRANSISTORS		
	Q221	2SD2144S (VW)	SI. TRANSISTOR	
	Q222	2SD2144S (VW)	SI. TRANSISTOR	
	Q223	2SD2144S (VW)	SI. TRANSISTOR	
	Q224	2SD2144S (VW)	SI. TRANSISTOR	
	Q225	DTA144ES	DIGITAL TRANSISTOR	
	Q351	DTA144ES	DIGITAL TRANSISTOR	
	Q352	DTC144ES	DIGITAL TRANSISTOR	
	Q353	DTA144ES	DIGITAL TRANSISTOR	
	Q671	2SA933S (RS)	SI. TRANSISTOR	
	Q672	2SC458 (C. D)	SI. TRANSISTOR	
	Q673	DTC143ES	DIGITAL TRANSISTOR	
	Q674	2SA933S (RS)	SI. TRANSISTOR	
	Q675	2SC458 (C. D)	SI. TRANSISTOR	
	Q677	2SA933S (RS)	SI. TRANSISTOR	
	Q678	2SC458 (C. D)	SI. TRANSISTOR	
	Q679	DTC143ES	DIGITAL TRANSISTOR	
		CAPACITORS		
	C201	QETB1HM-475E	4. 7MF 50V E. CAP.	
	C202	QETB1HM-475E	4. 7MF 50V E. CAP.	
	C203	QETB1HM-225	2. 2MF 50V AL E. CAP.	
	C204	QETB1HM-225	2. 2MF 50V AL E. CAP.	
	C205	QCBB1HK-561Y	560PF 50V CER. CAP.	
	C206	QCBB1HK-561Y	560PF 50V CER. CAP.	
	C207	QFN81HK-154	0. 15MF 50V METAL. MYLAR	
	C208	QFN81HK-154	0. 15MF 50V METAL. MYLAR	
	C209	QETB1HM-475E	4. 7MF 50V E. CAP.	
	C210	QETB1HM-475E	4. 7MF 50V E. CAP.	
	C211	QETB1HM-475E	4. 7MF 50V E. CAP.	
	C212	QETB1HM-475E	4. 7MF 50V E. CAP.	
	C213	QETB1HM-225	2. 2MF 50V AL E. CAP.	
	C214	QETB1HM-225	2. 2MF 50V AL E. CAP.	
	C215	QETB1HM-475E	4. 7MF 50V E. CAP.	
	C216	QETB1HM-475E	4. 7MF 50V E. CAP.	
	C225	QETB1HM-475E	4. 7MF 50V E. CAP.	
	C251	QETB1HM-475E	4. 7MF 50V E. CAP.	
	C252	QETB1HM-475E	4. 7MF 50V E. CAP.	
	C253	QCBB1HK-101Y	100PF 50V CER. CAP.	
	C254	QCBB1HK-101Y	100PF 50V CER. CAP.	
	C255	QETB1EM-476	47MF 25V AL E. CAP.	
	C256	QETB1EM-476	47MF 25V AL E. CAP.	
	C257	QETB1EM-476	47MF 25V AL E. CAP.	
	C258	QETB1EM-476	47MF 25V AL E. CAP.	
	C259	QCSB1HJ-100Y	10PF 50V CER. CAP.	
	C260	QCSB1HJ-100Y	10PF 50V CER. CAP.	
	C261	QCSB1HJ-100Y	10PF 50V CER. CAP.	
	C262	QCSB1HJ-100Y	10PF 50V CER. CAP.	
	C265	QETB1EM-226N	22MF 25V E. CAP.	
	C266	QETB1EM-226N	22MF 25V E. CAP.	
	C269	QCHB1EZ-223	0. 022MF 25V CER. CAP.	
	C270	QCHB1EZ-223	0. 022MF 25V CER. CAP.	
	C271	QFLB1HJ-272	2700PF 50V MYLAR CAP.	
	C272	QFLB1HJ-272	2700PF 50V MYLAR CAP.	
	C273	QCBB1HK-471Y	470PF 50V CER. CAP.	
	C274	QCBB1HK-471Y	470PF 50V CER. CAP.	
	C275	QFV81HJ-473	0. 047MF 50V THIN FILM CAP.	

△	Item	Parts Number	Description	Area
	C276	QFV81HJ-473	0. 047MF 50V THIN FILM CAP.	
	C277	QFLB1HJ-822	8200PF 50V MYLAR CAP.	
	C278	QFLB1HJ-822	8200PF 50V MYLAR CAP.	
	C279	QER51HM-684	0. 68MF 50V AL E. CAP.	
	C280	QER51HM-684	0. 68MF 50V AL E. CAP.	
	C281	QFV81HJ-104	0. 1MF 50V THIN FILM CAP.	
	C282	QFV81HJ-104	0. 1MF 50V THIN FILM CAP.	
	C283	QCSB1HJ-470	47PF 50V CER. CAP.	
	C284	QCSB1HJ-470	47PF 50V CER. CAP.	
	C287	QCBB1HK-561Y	560PF 50V CER. CAP.	
	C291	QCHB1EZ-223	0. 022MF 25V CER. CAP.	
	C292	QCBB1HK-331Y	330PF 50V CER. CAP.	
	C295	QCBB1HK-101Y	100PF 50V CER. CAP.	
	C296	QCBB1HK-101Y	100PF 50V CER. CAP.	
	C297	QCBB1HK-101Y	100PF 50V CER. CAP.	
	C298	QCBB1HK-101Y	100PF 50V CER. CAP.	
	C323	QCHB1EZ-223	0. 022MF 25V CER. CAP.	
	C324	QCHB1EZ-223	0. 022MF 25V CER. CAP.	
	C325	QCBB1HK-221Y	220PF 50V CER. CAP.	
	C341	QETB1HM-106	10MF 50V E. CAP.	
	C342	QETB1HM-106	10MF 50V E. CAP.	
	C351	QETB1HM-475E	4. 7MF 50V E. CAP.	
	C353	QETB1EM-226N	22MF 25V E. CAP.	
	C354	QETB1EM-226N	22MF 25V E. CAP.	
	C361	QETB1HM-475E	4. 7MF 50V E. CAP.	
	C362	QETB1HM-475E	4. 7MF 50V E. CAP.	
	C371	QCBB1HK-221Y	220PF 50V CER. CAP.	
	C381	QCBB1HK-331Y	330PF 50V CER. CAP.	
	C382	QCBB1HK-331Y	330PF 50V CER. CAP.	
	C385	QCBB1HK-331Y	330PF 50V CER. CAP.	
	C386	QCBB1HK-331Y	330PF 50V CER. CAP.	
	C387	QCBB1HK-331Y	330PF 50V CER. CAP.	
	C388	QCBB1HK-331Y	330PF 50V CER. CAP.	
	C389	QCBB1HK-331Y	330PF 50V CER. CAP.	
	C390	QCBB1HK-331Y	330PF 50V CER. CAP.	
	C393	QCBB1HK-331Y	330PF 50V CER. CAP.	
	C394	QCBB1HK-331Y	330PF 50V CER. CAP.	
	C395	QCBB1HK-331Y	330PF 50V CER. CAP.	
	C396	QCBB1HK-331Y	330PF 50V CER. CAP.	
	C397	QCBB1HK-331Y	330PF 50V CER. CAP.	
	C398	QCBB1HK-331Y	330PF 50V CER. CAP.	
	C399	QETB0JM-108N	1000MF 6. 3V E. CAP.	
	C661	QCSB1HJ-150Y	15PF 50V CER. CAP.	
	C662	QCSB1HJ-270Y	27PF 50V CER. CAP.	
	C663	QETB1HM-105	1MF 50V AL E. CAP.	
	C664	QCSB1HJ-100Y	10PF 50V CER. CAP.	
	C665	QCSB1HJ-100Y	10PF 50V CER. CAP.	
	C667	QETB1AM-477	470MF 10V E. CAP.	
	C668	QCHB1EZ-223	0. 022MF 25V CER. CAP.	
	C671	QETB1CM-107	100MF 16V AL E. CAP.	
	C672	QCHB1EZ-223	0. 022MF 25V CER. CAP.	
	C673	QETB1CM-476	47MF 16V AL E. CAP.	
	C674	QETB1HM-475E	4. 7MF 50V E. CAP.	
	C675	QETB1CM-476	47MF 16V AL E. CAP.	
	C676	QCSB1HJ-100Y	10PF 50V CER. CAP.	
	C681	QETB0JM-108N	1000MF 6. 3V E. CAP.	
	C682	QETB1HM-475E	4. 7MF 50V E. CAP.	
	C683	QETB0JM-108N	1000MF 6. 3V E. CAP.	
	C684	QETB1HM-475E	4. 7MF 50V E. CAP.	
	C685	QETB1HM-475E	4. 7MF 50V E. CAP.	
	C686	QETB0JM-108N	1000MF 6. 3V E. CAP.	
		RESISTORS		
	R201	QRD161J-104	100K 1/6W CARBON RES.	
	R202	QRD161J-104	100K 1/6W CARBON RES.	
	R203	QRD161J-104	100K 1/6W CARBON RES.	
	R204	QRD161J-104	100K 1/6W CARBON RES.	
	R205	QRD161J-393	39K 1/6W CARBON RES.	
	R206	QRD161J-393	39K 1/6W CARBON RES.	
	R207	QRD161J-224	220K 1/6W CARBON RES.	
	R208	QRD161J-224	220K 1/6W CARBON RES.	
	R209	QRD161J-102	1K 1/6W CARBON RES.	
	R210	QRD161J-102	1K 1/6W CARBON RES.	
	R211	QRD161J-104	100K 1/6W CARBON RES.	
	R212	QRD161J-104	100K 1/6W CARBON RES.	
	R213	QRD161J-104	100K 1/6W CARBON RES.	
	R214	QRD161J-104	100K 1/6W CARBON RES.	
	R215	QRD161J-102	1K 1/6W CARBON RES.	
	R216	QRD161J-102	1K 1/6W CARBON RES.	
	R217	QRD161J-102	1K 1/6W CARBON RES.	

■ Electrical Parts List (ENC-135)

△	Item	Parts Number	Description	Area
	R218	QRD161J-102	1K 1/6W CARBON RES.	
	R221	QRD161J-103	10K 1/6W CARBON RES.	
	R222	QRD161J-103	10K 1/6W CARBON RES.	
	R223	QRD161J-103	10K 1/6W CARBON RES.	
	R224	QRD161J-103	10K 1/6W CARBON RES.	
	R225	QRD161J-102	1K 1/6W CARBON RES.	
	R241	QRD161J-271	270 1/6W CARBON RES.	
	R242	QRD161J-271	270 1/6W CARBON RES.	
	R243	QRD161J-271	270 1/6W CARBON RES.	
	R244	QRD161J-271	270 1/6W CARBON RES.	
	R245	QRD167J-680	68 1/6W CARBON RES.	
△	R245	QRZ0077-680	68 1/4W FUSIBLE RES.	
	R246	QRD167J-680	68 1/6W CARBON RES.	
△	R246	QRZ0077-680	68 1/4W FUSIBLE RES.	
	R247	QRD161J-271	270 1/6W CARBON RES.	
	R248	QRD161J-271	270 1/6W CARBON RES.	
	R249	QRD167J-680	68 1/6W CARBON RES.	
△	R249	QRZ0077-680	68 1/4W FUSIBLE RES.	
	R250	QRD167J-680	68 1/6W CARBON RES.	
△	R250	QRZ0077-680	68 1/4W FUSIBLE RES.	
	R253	QRD161J-104	100K 1/6W CARBON RES.	
	R254	QRD161J-104	100K 1/6W CARBON RES.	
	R255	QRD161J-393	39K 1/6W CARBON RES.	
	R256	QRD161J-393	39K 1/6W CARBON RES.	
	R257	QRD161J-103	10K 1/6W CARBON RES.	
	R258	QRD161J-103	10K 1/6W CARBON RES.	
	R259	QRD161J-103	10K 1/6W CARBON RES.	
	R260	QRD161J-103	10K 1/6W CARBON RES.	
	R261	QRD161J-303Y	30K 1/6W CARBON RES.	
	R262	QRD161J-303Y	30K 1/6W CARBON RES.	
	R263	QRD161J-123	12K 1/6W CARBON RES.	
	R264	QRD161J-123	12K 1/6W CARBON RES.	
	R265	QRD161J-472	4.7K 1/6W CARBON RES.	
	R266	QRD161J-472	4.7K 1/6W CARBON RES.	
	R267	QRD161J-183	18K 1/6W CARBON RES.	
	R268	QRD161J-183	18K 1/6W CARBON RES.	
	R269	QRD161J-912	9.1K 1/6W CARBON RES.	
	R270	QRD161J-912	9.1K 1/6W CARBON RES.	
	R271	QRD161J-243	24K 1/6W CARBON RES.	
	R272	QRD161J-243	24K 1/6W CARBON RES.	
	R273	QRD161J-103	10K 1/6W CARBON RES.	
	R274	QRD161J-103	10K 1/6W CARBON RES.	
	R275	QRD161J-333	33K 1/6W CARBON RES.	
	R276	QRD161J-333	33K 1/6W CARBON RES.	
	R279	QRD161J-681	680 1/6W CARBON RES.	
	R280	QRD161J-681	680 1/6W CARBON RES.	
	R325	QRD161J-102	1K 1/6W CARBON RES.	
	R326	QRD161J-472	4.7K 1/6W CARBON RES.	
	R331	QRD161J-473	47K 1/6W CARBON RES.	
	R332	QRD161J-473	47K 1/6W CARBON RES.	
	R333	QRD161J-163	16K 1/6W CARBON RES.	
	R334	QRD161J-163	16K 1/6W CARBON RES.	
	R335	QRD161J-104	100K 1/6W CARBON RES.	
	R336	QRD161J-104	100K 1/6W CARBON RES.	
	R337	QRD161J-271	270 1/6W CARBON RES.	
	R338	QRD161J-271	270 1/6W CARBON RES.	
	R341	QRD161J-104	100K 1/6W CARBON RES.	
	R342	QRD161J-104	100K 1/6W CARBON RES.	
	R343	QRD161J-104	100K 1/6W CARBON RES.	
	R344	QRD161J-104	100K 1/6W CARBON RES.	
	R345	QRD161J-432	4.3K 1/6W CARBON RES.	
	R346	QRD161J-432	4.3K 1/6W CARBON RES.	
	R347	QRD161J-103	10K 1/6W CARBON RES.	
	R348	QRD161J-103	10K 1/6W CARBON RES.	
	R351	QRD161J-102	1K 1/6W CARBON RES.	
	R353	QRD161J-821	820 1/6W CARBON RES.	
	R354	QRD161J-821	820 1/6W CARBON RES.	
	R355	QRD161J-103	10K 1/6W CARBON RES.	
	R356	QRD161J-103	10K 1/6W CARBON RES.	
	R361	QRD161J-104	100K 1/6W CARBON RES.	
	R362	QRD161J-104	100K 1/6W CARBON RES.	
	R363	QRD161J-103	10K 1/6W CARBON RES.	
	R363	QRD161J-104	100K 1/6W CARBON RES.	
	R364	QRD161J-103	10K 1/6W CARBON RES.	
	R364	QRD161J-104	100K 1/6W CARBON RES.	
	R365	QRD161J-182	1.8K 1/6W CARBON RES.	
	R365	QRD167J-822	8.2K 1/6W CARBON RES.	
	R366	QRD161J-182	1.8K 1/6W CARBON RES.	
	R366	QRD167J-822	8.2K 1/6W CARBON RES.	

△	Item	Parts Number	Description	Area
	R371	QRD161J-471	470 1/6W CARBON RES.	
	R372	QRD161J-221	220 1/6W CARBON RES.	
	R381	QRD161J-471	470 1/6W CARBON RES.	
	R382	QRD161J-471	470 1/6W CARBON RES.	
	R385	QRD161J-471	470 1/6W CARBON RES.	
	R386	QRD161J-471	470 1/6W CARBON RES.	
	R387	QRD161J-471	470 1/6W CARBON RES.	
	R388	QRD161J-471	470 1/6W CARBON RES.	
	R389	QRD161J-471	470 1/6W CARBON RES.	
	R390	QRD161J-471	470 1/6W CARBON RES.	
	R393	QRD161J-471	470 1/6W CARBON RES.	
	R394	QRD161J-471	470 1/6W CARBON RES.	
	R395	QRD161J-471	470 1/6W CARBON RES.	
	R396	QRD161J-471	470 1/6W CARBON RES.	
	R397	QRD161J-471	470 1/6W CARBON RES.	
	R398	QRD161J-471	470 1/6W CARBON RES.	
	R661	QRD161J-221	220 1/6W CARBON RES.	
	R662	QRD161J-221	220 1/6W CARBON RES.	
	R663	QRD161J-221	220 1/6W CARBON RES.	
	R671	QRD167J-151	150 1/6W CARBON RES.	
	R672	QRD167J-152	1.5K 1/6W CARBON RES.	
	R673	QRD161J-271	270 1/6W CARBON RES.	
	R674	QRD167J-151	150 1/6W CARBON RES.	
	R675	QRD161J-471	470 1/6W CARBON RES.	
	R675	QRD167J-152	1.5K 1/6W CARBON RES.	
	R676	QRD161J-221	220 1/6W CARBON RES.	
	R676	QRD161J-271	270 1/6W CARBON RES.	
	R677	QRD167J-151	150 1/6W CARBON RES.	
	R678	QRD167J-152	1.5K 1/6W CARBON RES.	
	R679	QRD161J-271	270 1/6W CARBON RES.	
	R681	QRD161J-750	75 1/6W CARBON RES.	
	R682	QRD161J-473	47K 1/6W CARBON RES.	
	R683	QRD161J-331	330 1/6W CARBON RES.	
	R684	QRD161J-750	75 1/6W CARBON RES.	
	R685	QRD161J-750	75 1/6W CARBON RES.	
	R686	QRD161J-473	47K 1/6W CARBON RES.	
	R687	QRD161J-331	330 1/6W CARBON RES.	
	R688	QRD161J-750	75 1/6W CARBON RES.	
	R689	QRD161J-331	330 1/6W CARBON RES.	
	R690	QRD161J-750	75 1/6W CARBON RES.	
	R691	QRD161J-750	75 1/6W CARBON RES.	
	R691	QRD167J-680	68 1/6W CARBON RES.	
	R692	QRD161J-473	47K 1/6W CARBON RES.	
	R693	QRD167J-822	8.2K 1/6W CARBON RES.	
	R694	QRD161J-512	5.1K 1/6W CARBON RES.	
	R695	QRD161J-102	1K 1/6W CARBON RES.	
		OTHERS		
		EMW10680-003	PRINTED BOARD	
	J301	EMN00TV-423AJ2	PIN JACK	
	J302	EMN00TV-423AJ2	PIN JACK	
	J304	QNN0027-001	PIN JACK	
	J371	QMS3501-020	PIN JACK	
	J601	EMN00YV-217A	PIN JACK	
	J602	EMN00TV-116A	PIN JACK	
	J603	EMN00TV-116A	PIN JACK	
	J604	EMN00YV-217A	PIN JACK	
	L661	EQL4004-220	INDUCTOR	
	L671	EQL4004-R22	INDUCTOR	
	X661	ECX0177-3447EWT	CRYSTAL	
	CN085	EMV7158-018	CONNECT TERMINAL	
	CN101	EMV7163-012	CONNECT TERMINAL	
	CN302	EMV7163-004	CONNECT TERMINAL	
	CN305	VMC0163-029	CONNECT TERMINAL	
	CN307	EMV7163-005	CONNECTOR	
	CN308	EMV7163-010	CONNECT TERMINAL	
	CN312	EMV5163-004R	CONNECT TERMINAL	
	CN318	EMV5163-010R	CONNECT TERMINAL	
	CN327	EMV5163-005R	CONNECTOR	
	CN361	EMV5163-007R	CONNECT TERMINAL	
	CN371	EMV7163-007	CONNECT TERMINAL	
	CN601	EMV7163-005	CONNECTOR	
	CN602	EMV5109-003B	CONNECT TERMINAL	
	CN603	EMV5109-006B	CONNECT TERMINAL	
	CN621	EMV5163-005R	CONNECTOR	
	CN702	EWS296-0134	SOCKET WIRE ASSY	
	CN841	EMV5163-007R	CONNECT TERMINAL	
	PW301	QWE350-13RR	VINYL WIRE	

■ Accessories List

Block No. **M2MM**

△	Item	Parts Number	Parts Name	Q'ty	Description	Area
	1	LET0015-001A	INSTRUCTION BOOK	1		EF G
	1	LET0015-002A	INSTRUCTION BOOK	1		EN
	1	LET0015-003A	INSTRUCTION BOOK	1		BS
	2	E43486-340A	SAFETY SHEET	1		BS
	3	BT-20134	WARRANTY CARD	1		G
	3	BT-54003-1	WARRANTY CARD	1		BS
	4	BT-20066A	DISTRIBUTOR LIST	1		BS
	5	EWP503-001	ANTENNA WIRE	1		
	6	E309758-001	POLY BAG	1		
	7	RM-SR5THRU	WIRE-LESS REMOTE CONTROL	1		
	8	EQB4001-015	LOOP ANTENNA	1		
	9	R6PPTT-2ST	BATTERY	2		

# Packing Materials and Part Numbers

Block No. **M3MM**

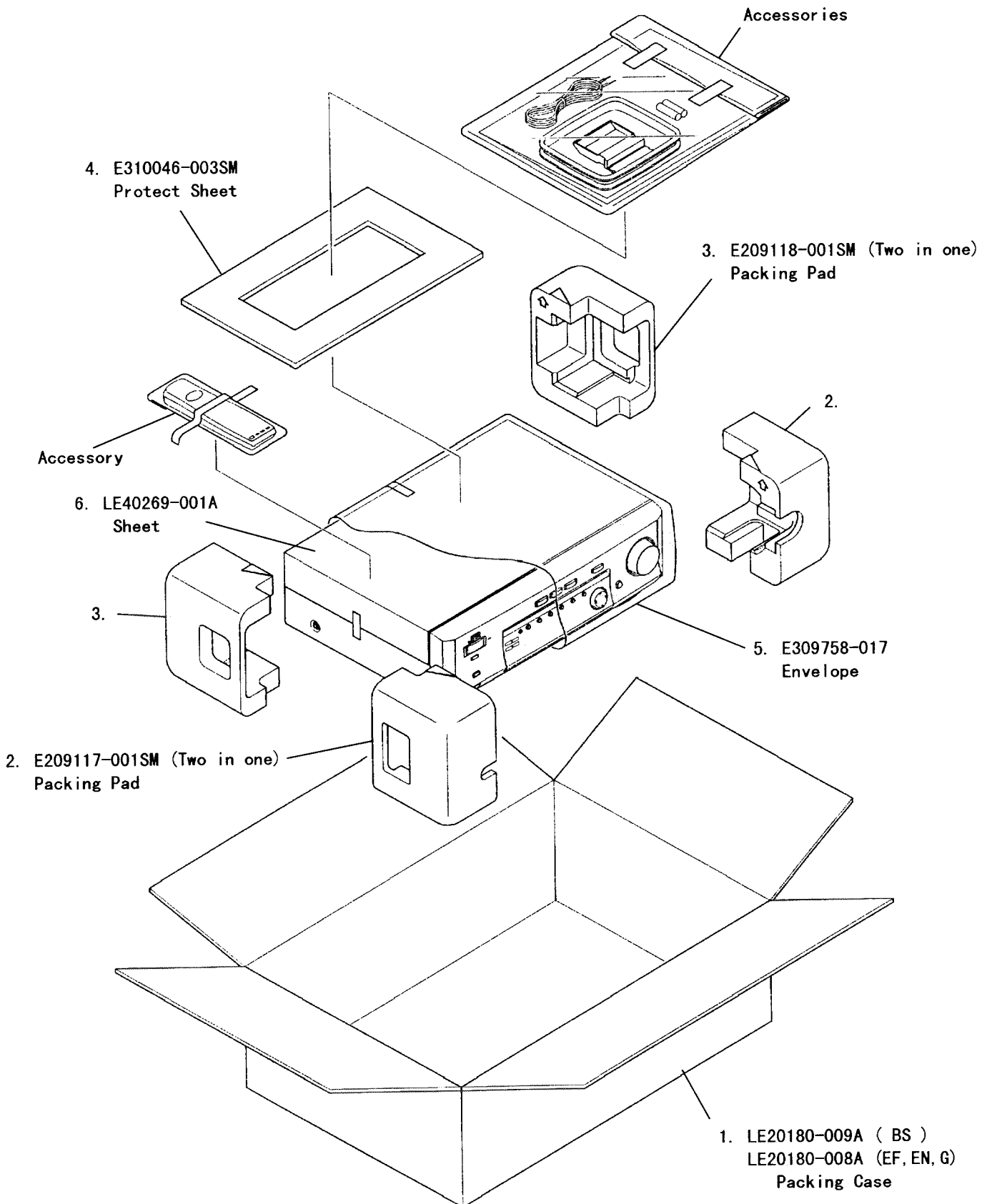

RX-5THRBK

**JVC**

VICTOR COMPANY OF JAPAN, LIMITED  
AUDIO PRODUCTS DIVISION 10-1, 1-chome, Ohwatari-machi, Maebashi-city, Japan